



Pant Style & Design Manual

MTM Design Manual Instructions

Customer Notic

- 1 . The manual is used by business departments authorized by the platform; The business department can carry out the marketing promotion according to the market situation
- 2 . The option to insert "△" logo in the design manual is the default standard configuration in each design category
- 3 . If the customer does not choose other personalized design options in the type design category, that is, default on behalf of the customer, and the default standard configuration option is permitted, we will design and manufacture according to the default standard configuration.
- 4 . The design options in the same category in this design manual can only be selected, not repeated; Customers especially avoid contradictory or lack of logical design. For example, they choose "no pleated pants" and "pleat depth 3.2cm". They choose "no lining pants" and also choose " half front lining, pocketing is outside"
- 5 . When customers place orders through the platform, the options that involve the default configuration do not have to be entered into the system, but only the personalized style design options
- 6 . Personalized design options required by the customer as long as the manual is defined, the design code must be input. If the customer's personalized design cannot be met by hand, the application can be submitted to the platform. If the application is approved by the platform, the design code can be regularly classified, defined, summarized and published.
- 7 . We will constantly update the r&d and design options according to the market situation, and refine and improve the content of the existing design options according to the actual situation to make them clearer and update the versions regularly.
- 8 . The right to interpret the design manual belongs to RCMTM
- 9 . The customer has understood and accepted the above requirements before using this manual.

2018

Pant Style

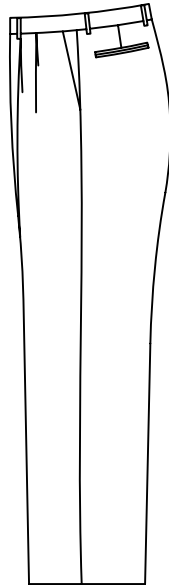

T-3001

△ Standard pant style

Waistband Width

△T-301C	waistband width 3.5cm
T-301E	waistband width 3.8cm
T-301D	waistband width 4.0cm
T-301F	waistband width 5.0cm
T-3015	waistband width 4.5cm

Waistband Style

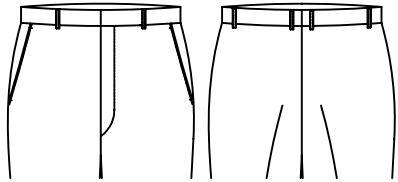

T-3010

△ standard waistband

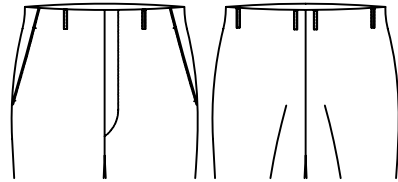

T-3011

Front&Back continuous

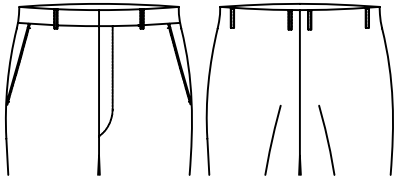

T-3012

uncontinued front waist
with continued back waist

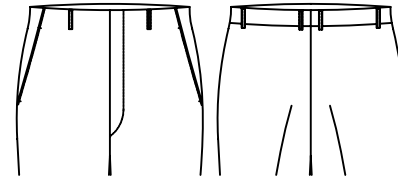

T-3013

front continued waist

Pleats Style

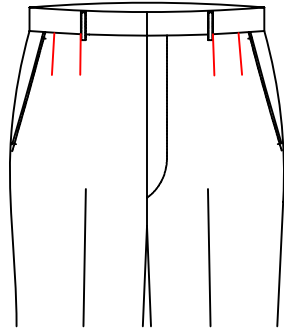

T-302Y

Plain front with double darts

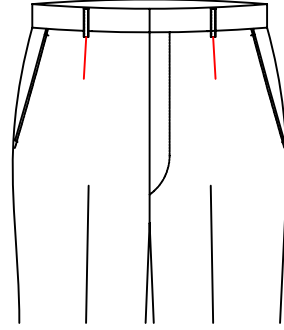

T-302M

Plain front with single dart

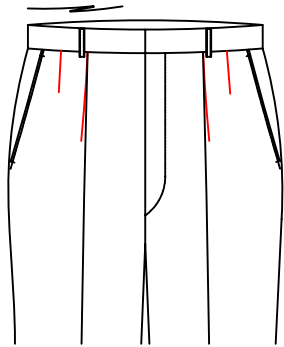

T-302 R

Single pleat pant with side dart

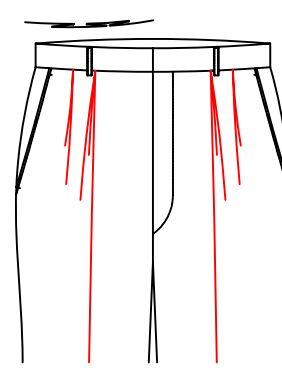

T-3028

One opposite pleat+one
pleat forward side seam

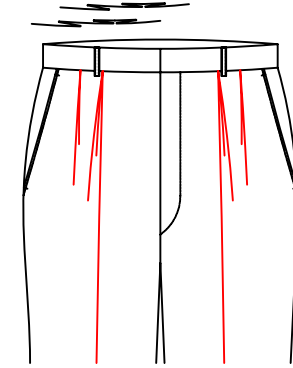

T-3029

One opposite pleat+one
pleat forward fly

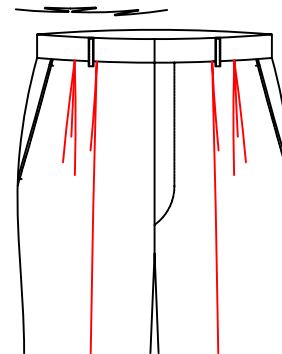

T-302A

One pleat forward side seam
+one opposite pleat

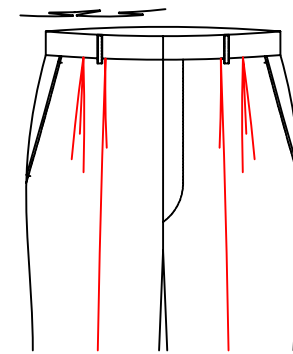

T-302B

One pleat forward fly
+one opposite pleat

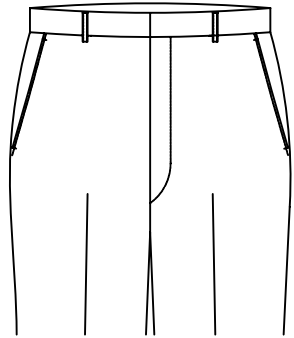

T-3020

Plain front seat and waist difference larger than 18.5cm. will have dart

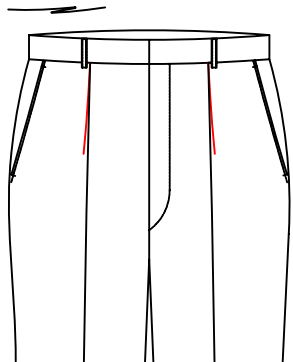

T-3021

△
Single pleat forward side seam

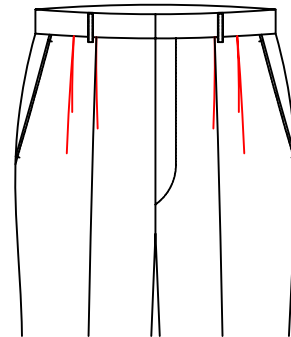

T-3024

Double pleats forward fly



T-3025

TriPLICATE pleats forward side seam

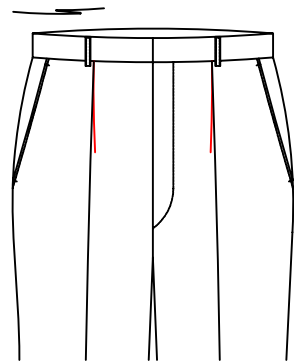

T-3022

Single pleat forward fly

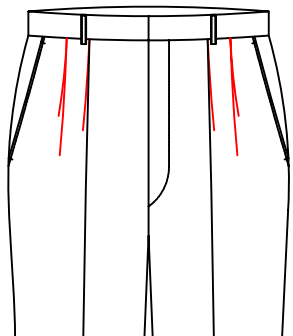

T-3023

Double pleats forward side seam



T-3026

TriPLICATE pleats forward fly

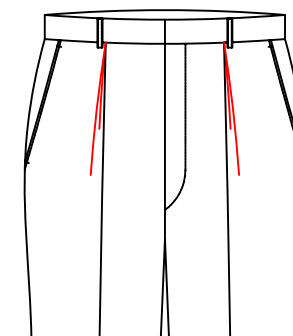

T-3027

One opposite pleat

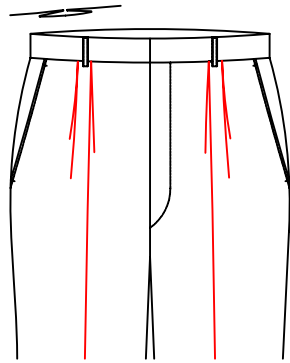

T-302P
One box pleat

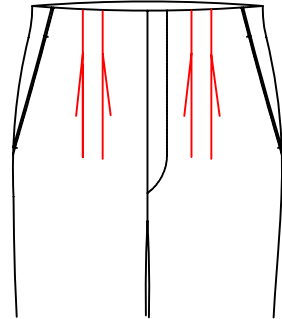

T-302K
Front pleats in line with belt loops

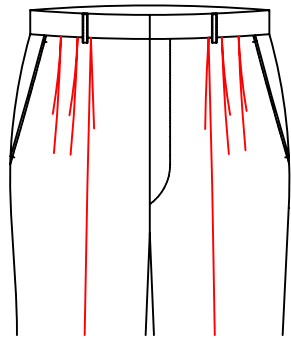

T-302J
One box pleat+one pleat
forward side seam

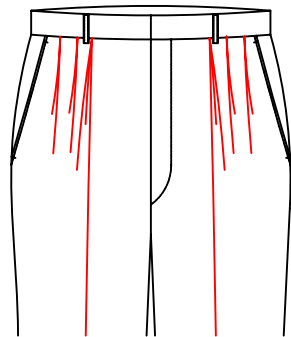

T-30P2
one opposite pleat+double
pleats forward side seam

Pleat distance

T-30P1 Space between front pleats:3.8cm
between 1st and 2nd pleat

Pleat Depth

T-302Z Pleat Depth (1.5cm)
T-302H Pleat Depth (cm):2.0
△ T-302E Pleat Depth (cm):2.5
T-302F Pleat Depth (cm):3.2
T-302G Pleat Depth (cm):3.8
T-302N Pleat Depth (cm):4.4

Front Pleat net length

T-30Z0 Opened pant pleats(pleat length 0cm)
△ T-30Z1 1.3cm length of front pleat
T-30Z2 1.9cm length of front pleat
T-30Z3 2.5cm length of front pleat
T-30Z4 3.2cm length of front pleat
T-30Z5 3.8cm length of front pleat

Front pleat knot form

T-319E Front pleat with 0.6 cm horizontal knot
T-319H Front pleat with 1 cm horizontal knot

Front Pocket Style



T-3100
2.0 cm slant pocket



T-3101
3.2cm slant pocket

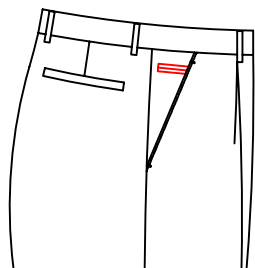

T-3105
5.1 slant pocket+besom
ticket pocket(8cm)

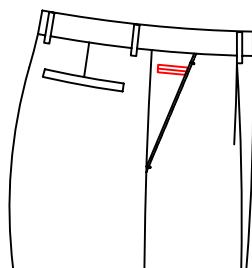

T-3106
5.1 slant pocket with decorative 8cm
width double besom ticket pocket

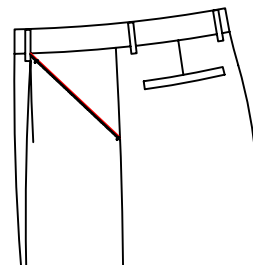

T-3123
Very slant pocket with stripe

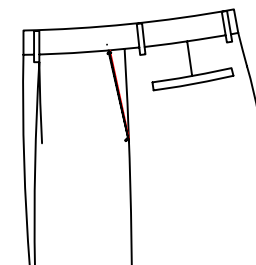

T-3124
2.5 slant pocket with stripe

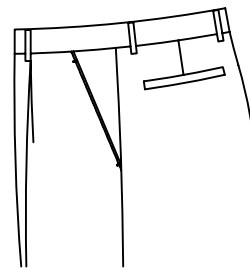

T-3102
5.1cm slant pocket

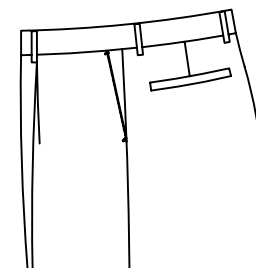

T-3104
△ 2.5 slant pocket

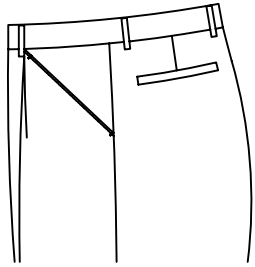

T-3103
Very slant pocket

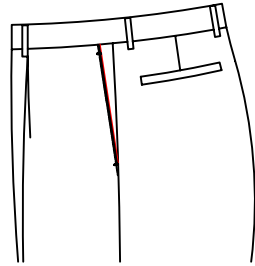

T-3120
2.0 cm slant pocket with stripe

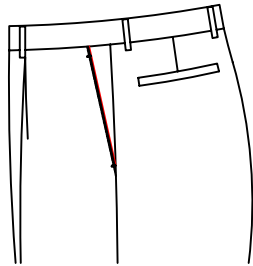

T-3121
3.2cm slant pocket with stripe

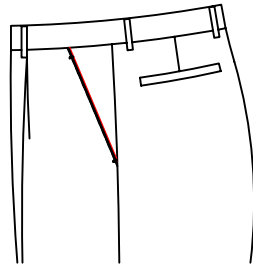

T-3122
5.1cm slant pocket with stripe

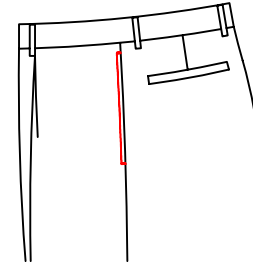

T-3130
Sideseam pocket

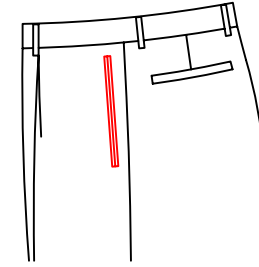

T-3131
Double besom pocket

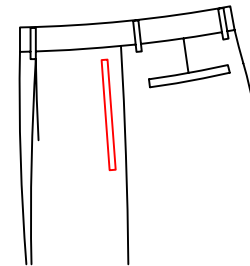

T-3132
Welt pocket

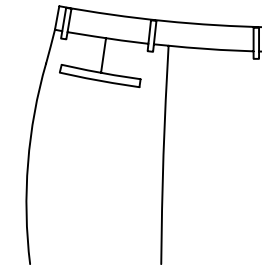

T-313C
No front pocket

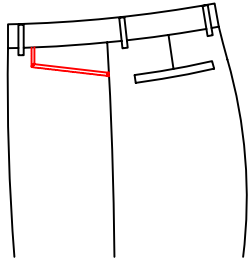

T-3133
Square jeans pocket

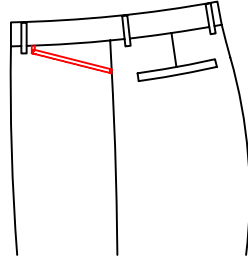

T-3138
DL jeans pocket

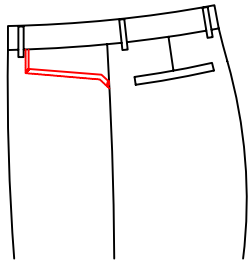

T-3134
Diamond jeans pocket

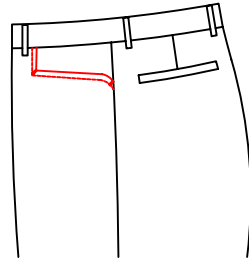

T-3135
Arc jean front pocket

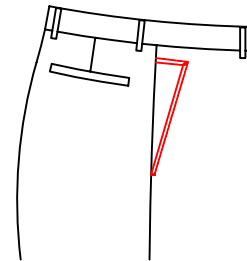

T-313B
slant pokcet with sqaure point

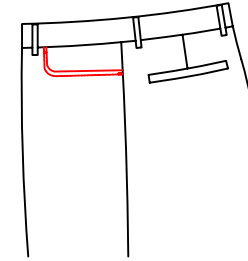

T-3136
Round jeans pocket

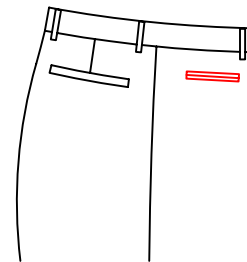

T-3139
stright double besom front pocket

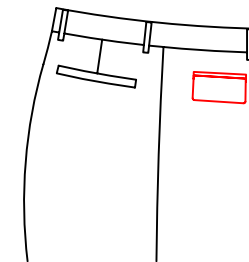

T-313A
stright double besom front
pocket with square flap

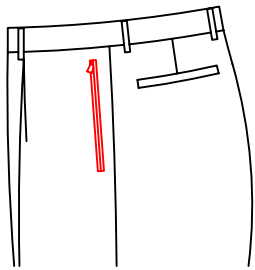

T-313D

front double besom
pocket with zipper

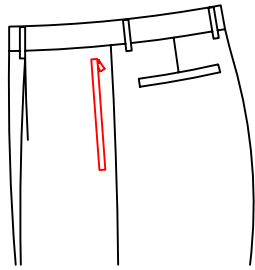

T-313E

front welt pocket with zipper

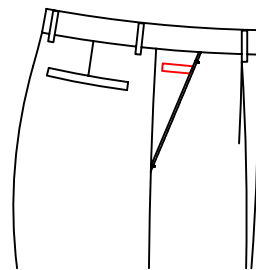

T-3107

5.1 slant front pocket
with welt ticket pocket

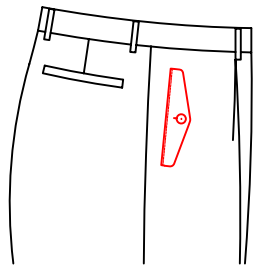

T-313G

Front decorative diamond-shaped
flap with buttonhole button pocket
(flap net 0.15 top stitch according
to the position of the welt front
pocket)

Front pocket openings styles

- T-3140 front pocket split seam with customer appointed fabric-
- T-3142 front slant pocket with customer appointed fabric-
- T-314K The opening of front pockets -1.0cm
- T-314L The opening of front pockets -2.0cm
- T-314M The opening of front pockets +2.0cm
- T-314N The opening of front pockets +1.0cm
- T-314P Front pocket welt with satin
- T-3153 Only for jean pocket customer appointed 0.3cm piping on front pockets-
- T-3154 front (slant) pocket add 0.3cm fabric cover cord piping, customer appoint piping-
- T-314V Front pocket 0.8 cm splice

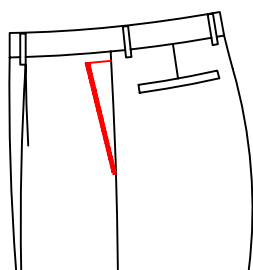

T-3149

customer appoint fabric for 0.8cm splice on front pocket

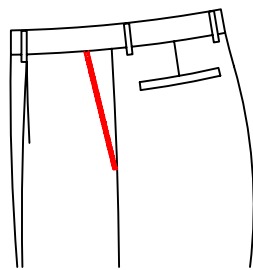

T-3150

customer appoint fabric for 1.0cm splice on front pocket

waistband pocket style

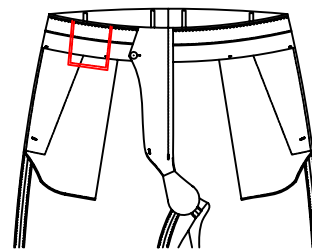

T-3161

left waist card bag

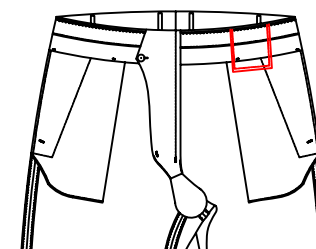

T-3162

right waist card bag

- T-3164 Left and right car pockets (between the inside waistband and outside waistband the width of the opening 12cm, the depth is 12cm)
- T-3167 Left car pockets (between the inside waistband and outside waistband, the width of the opening 12cm, the depth is 12cm)
- T-3168 right car pockets (between the inside waistband and outside waistband, the width of the opening 12cm, the depth is 12cm)

Front pocketing style

- T-3144 add front pocketing depth by 2cm
- T-3145 reduce front pocketing depth by 2cm
- T-3146 reduce front pocketing depth by 3cm
- T-3147 reduce front pocketing depth by 4cm
- T-3163 reduce front pocketing by 6cm
- T-314E add 4cm to the width 4cm to the depth to the front pocket
- T-3151 add front pocketing depth by 5.0cm

Watch Pocket Style

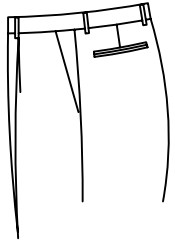

△ T-3169

No watch pocket

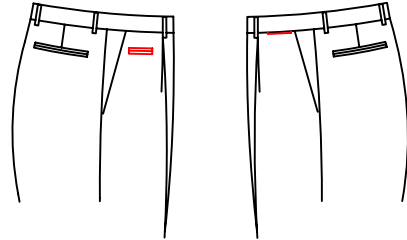

T-318T

double besom front pocket
w/left watch pocket

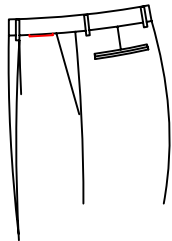

T-3170

Normal left watch pocket

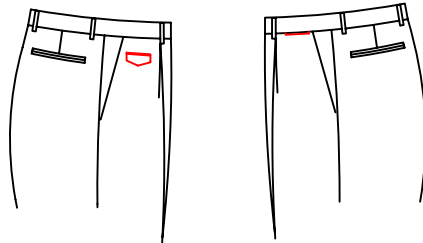

T-318R

right watch pocket with diamond
flap left watch pocket



T-3171

besom left pocket

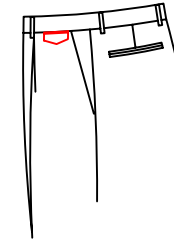

T-3174

Left watch pocket with diamond flap

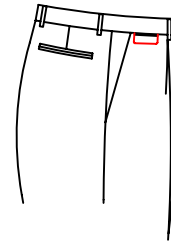

T-3175

Right watch pocket with square flap

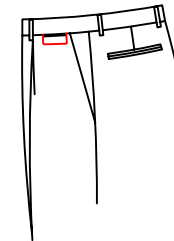

T-3177

Left watch pocket with square flap

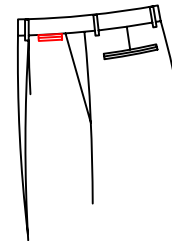

T-3178

double besome left watch pocket

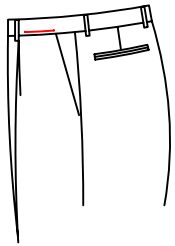

T-3179

Normal left watch pocket
7.6*7.6



T-318B

Normal watch pocket,
opening 10cm

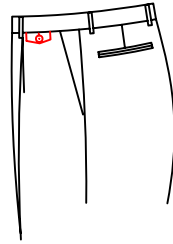

T-317A

left decorative pocket
with diamond flap,
button and buttonhole

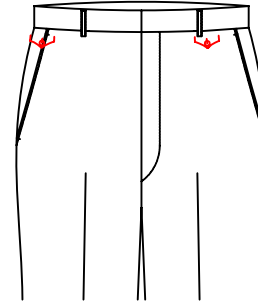

T-317F

Front decorative large pointed
flap with buttonhole&button
left and right watch pocket

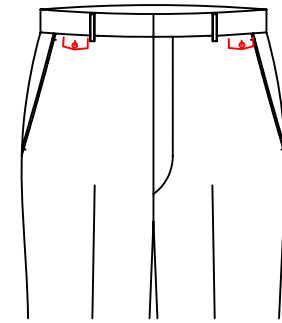

T-317G

Front decorative micro-diamond
flap with buttonhole&button
left and right watch pocket

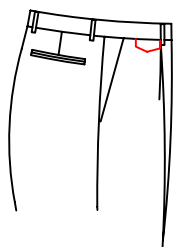

T-318G

besom left pocket & Right
watch pocket with diamond flap

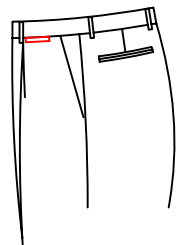

T-318Z

Normal left pocket & Right
watch pocket with diamond flap

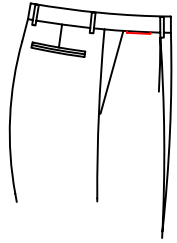

T-3180

Normal right watch pocket

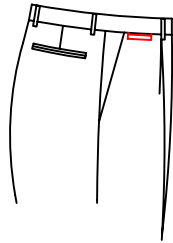

T-3181

Right welt watch pocket

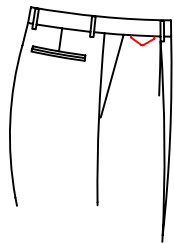

T-3182

right watch pocket with triangle flap

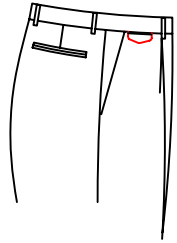

T-3184

Right watch pocket with diamond flap

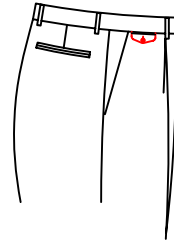

T-318Q

Right decorated watch pocket with diamond flap and button

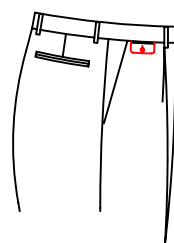

T-3185

Right watch pocket with square flap with button

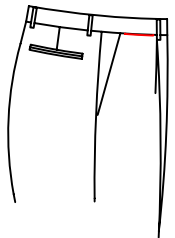

T-317E

normal right watch pocket
(open of of the pocket 7.6cm
pocket depth 7.6cm).

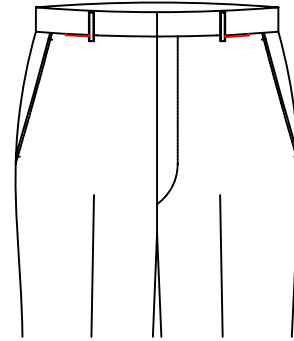

T-3189

Normal left and right watch pocket

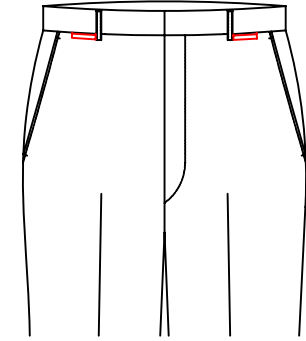

T-318H

Besom left pocket, right watch pocket

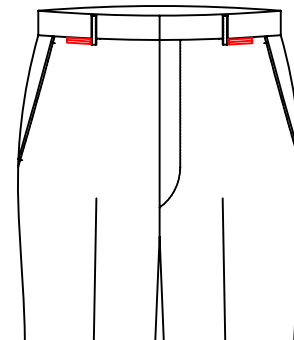

T-318J

double besome left and right watch pocket

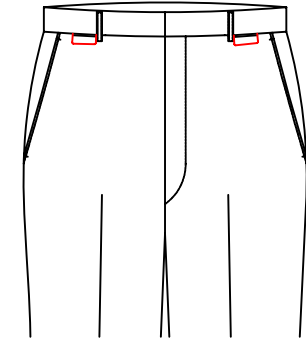

T-318K

Left,Right watch pocket with square flap



T-3186

Right watch pocket with diamond flap and button

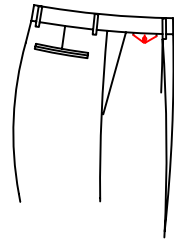

T-3187

Triangle flap, button on right watch pocket

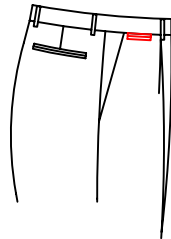

T-3188

double besome right watch pocket

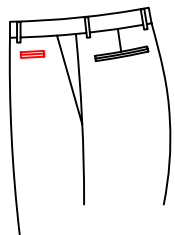

T-318L

double besome left watch pocket 5cm under waist and mouth width is 7cm

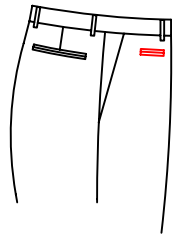

T-318P

ABP double besome right watch pocket (5cm below waistseam / pocket opening 7cm)

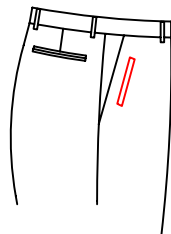

T-318W

vertical right welt watch pocket (parallel to pocket open 3.5cm / 4cm under waistseam / pocket opening 10cm)

Inner watch pocket style

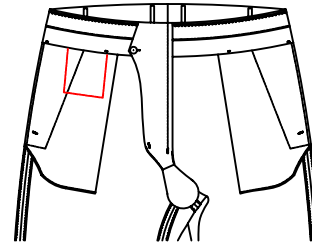

T-3173

Left inner watch pocket

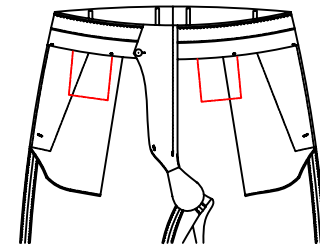

T-3176

Left and right inner watch pocket

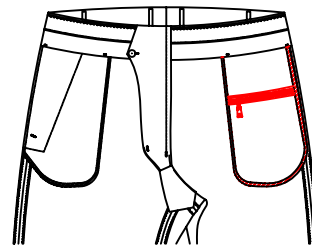

T-318U

ETQ inner watch pocket with zip inside

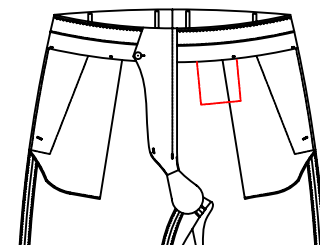

T-3183

right inner watch pocket

Watch Pocket welt fabric

T-318M outside pocket besome uses appointed fabric-
T-319F normal right and left watch pocket opening 4.5cm

Watch Pocekt Specifications

T-318S inner watch pocket appointed depth and width:12cm*8cm
T-318V inner watch pocket appointed depth and width:10cm*10cm
T-318Y inner watch pocket appointed depth and width:7.6cm*7.6cm

Seam fixing style for front large pocket

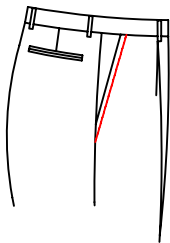

T-3196

Temporary hand sawing
on front pocket

T-319B
Blind stitch on
front pocket

Front Pocket Bartack Style



T-3190
front pocket-no
bartack

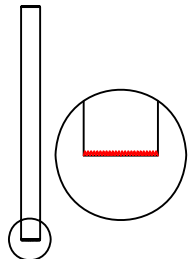

T-3191
△ front pocket-I
shape bartack

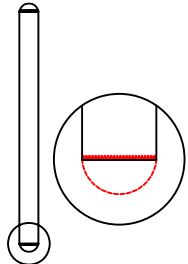

T-3192
'D' bartack(only welt
and double besom pocket
can choose)

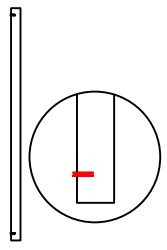

T-3193
front pocket edge with
'L'-shape bartack

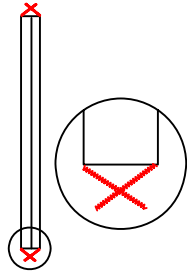

T-3194
Front besom or welt
pockets with X bartack

Front Pocket Sticking Style

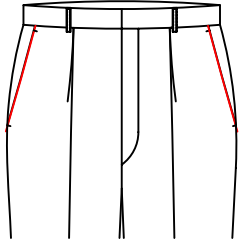

T-3302

fabric label in the center of right front waistband(The fabric number which start from DA does not use this craft)

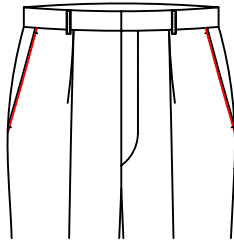

T-31A1

0.15 top stitching for front pocket

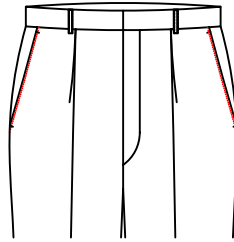

T-31A2

0.15 pick stitching for front pocket

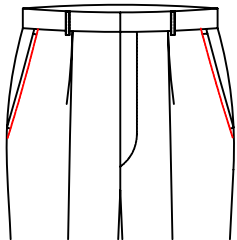

△ T-31A3

0.6 top stitching for front pocket

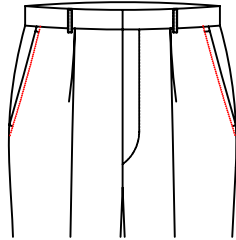

T-31A4

0.6cm wide pick stitch on front pkt

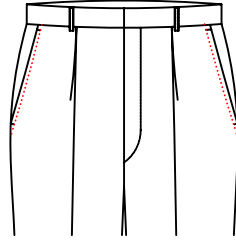

T-31A5

0.6 pick stitching for front pocket

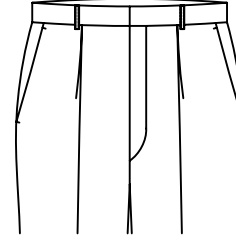

T-31A6

no top stitch on front pockepts

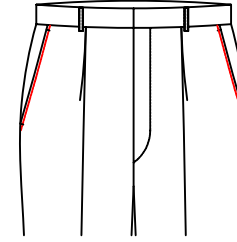

T-31A8

0.3cm top stitching for front pocket

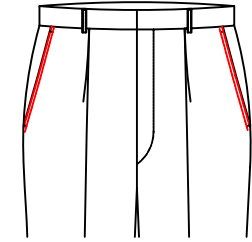

T-31A9

Front pocket with 0.1*0.7 top stitching

Back Pocket Style

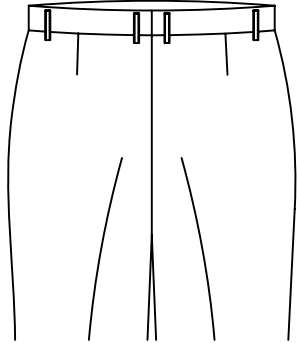

T-31A0

No back pocket

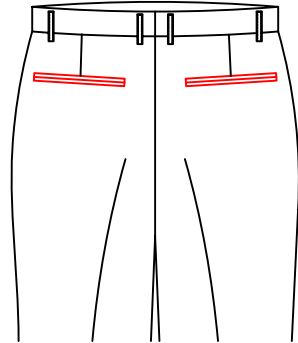

T-3200

double besom back pocket
(no buttons and buttonholes)

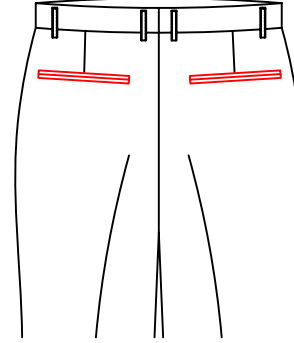

T-320L

Double besom hide
button back pocket

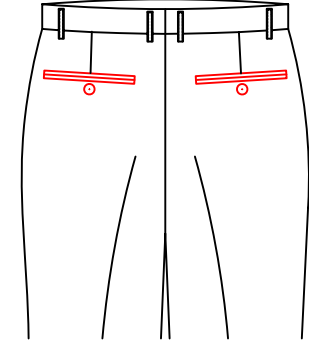

T-320V

double besom decorative
back pocket with buttons
and no buttonhole

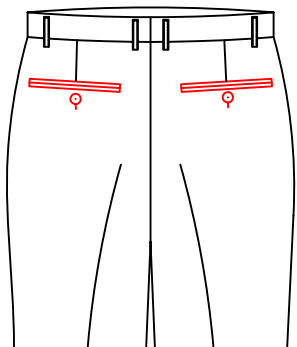

T-3201

△ double besom with
button back pockets

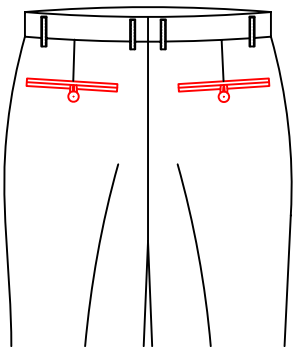

T-3202

Double besom with
tab and button back
pockets

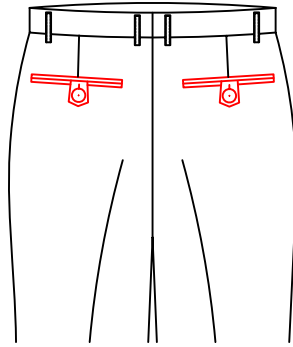

T-3203

Double besom with
pointed tab and
button back pocket

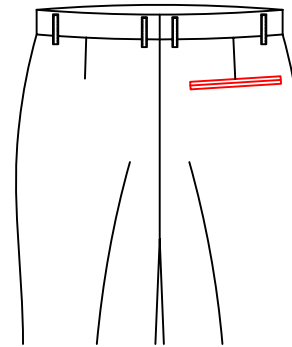

T-320N

double welt left
decoration pocket,
without button and
buttonhole, no right
pocket

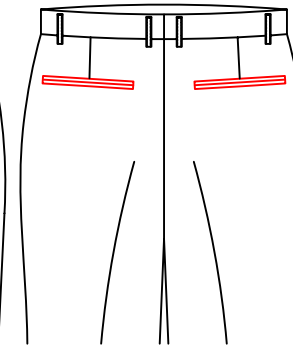

T-32PA

double welt pocket
with pointed tab,
button and buttonhole
(button and buttonhole
inside of the pocket)

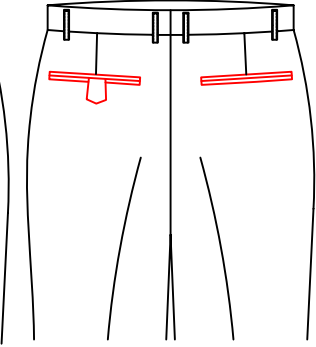

T-32LA

double welt with tab
left pocket, double
welt right pocket
(no button and buttonhole)

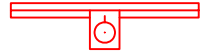

T-32C1

double besom with square tab with button back pocket



T-32C2

Double besom with round tab and button back pockets



T-3205

back pockets with zipper



T-3206

double besome decorative back pocket

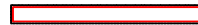

T-3220

Besom back pocket

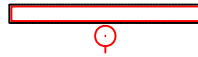

T-3221

Beam pocket w/button

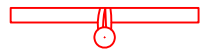

T-3224

Welt back pockets with loop and button



T-31A7

double besom back pocket with lower besom 1.0cm width and upper besom 0.5cm width



T-320P

welt back pocket with zipper



T-3210

Back pocket with flap

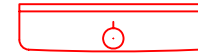

T-3211

Back pocket with button & buttonhole on flap



T-32C3

knife shape back pocket



T-32C4

knife shape w/ button back pocket



T-3212

back pocket with diamond flap

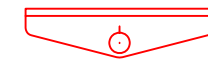

T-3213

back pocket with diamond flap and button&buttonhole



T-32C5

back pocket with semi-point flap



T-32C6

back pocket with button & buttonhole on semi-point flp

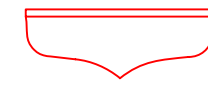

T-3214

Back pocket with pointed flap

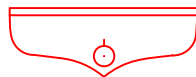

T-3215

Pointed flap back pocket with buttonhole and button

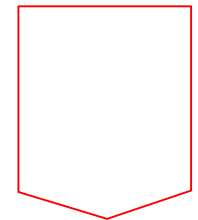

T-3230

Back patch pocket with pointed bottom

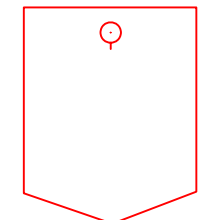

T-3231

Point patch pocket with button

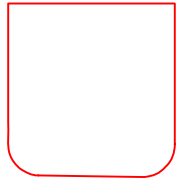

T-3232

Round patch
back pocket

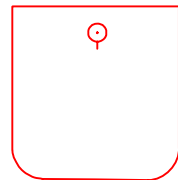

T-3233

rounded patch back
pocket with button
and buttonhole

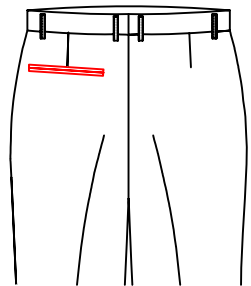

T-320E

Double besom left back
pocket, no right back
pocket

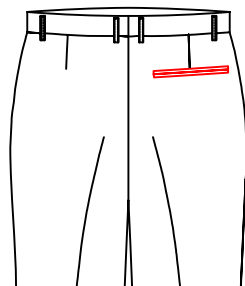

T-320F

Double besom right
back pocket, no
left back pocket

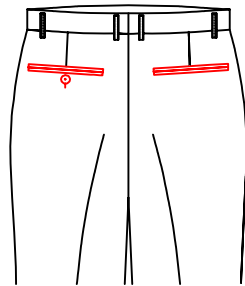

T-322E

double besom left
back pocket with
button and button hole
/double besom decorating
right back pocket

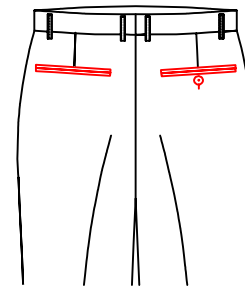

T-322F

double besom right
back pocket with
button and button hole
/double besom decorating
left back pocket

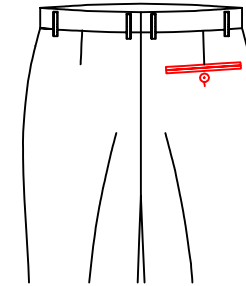

T-320G

Double besom right
back pocket with
button and buttonhole,
no left back pocket

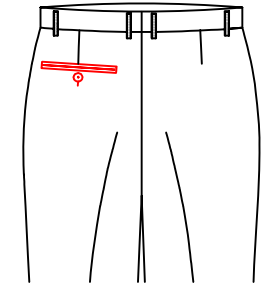

T-32C7

Double besom left
back pocket with
button and buttonhole,
no right back pocket

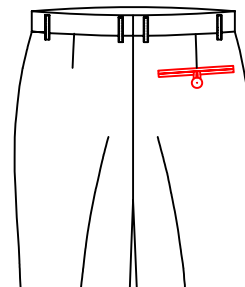

T-32A1

Only double besom
right back pocket
with tab and button ,
no left back pocket

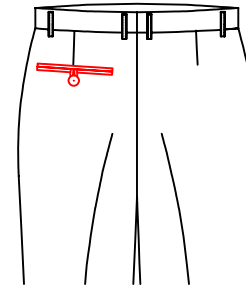

T-3278

Only double besom
left back pocket
with tab and button ,
no right back pocket

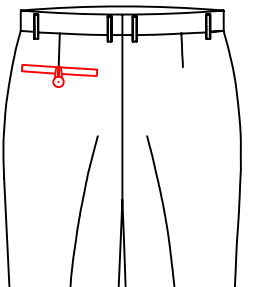

T-3227

Only welt with tap
on left back pocket,
no right back pocket

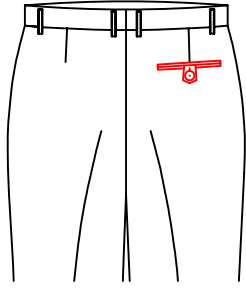

T-32C9

Only double besom right back pocket with pointed tab and button, no left back pocket

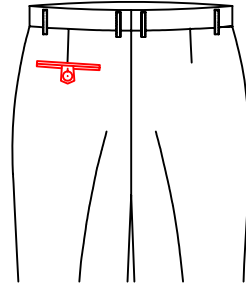

T-32D1

Only double besom left back pocket with pointed tab and button, no right back pocket

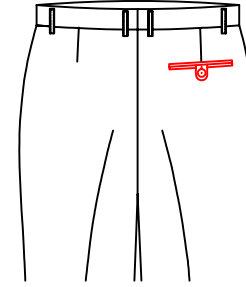

T-32D4

Double besom round tab right back pocket with button and buttonhole, no left back pocket

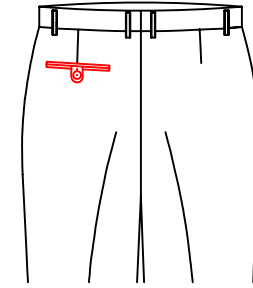

T-32D5

Double besom round tab left back pocket with button and buttonhole, no right back pocket

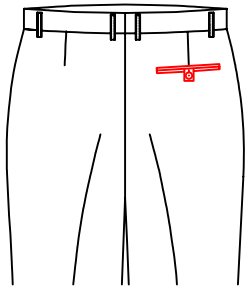

T-32D2

Only double besom right back pocket with square tab and button, no left back pocket

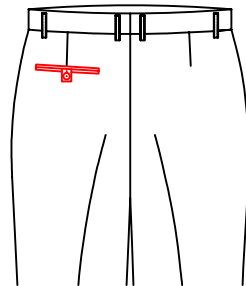

T-32D3

Only double besom left back pocket with square tab and button, no right back pocket

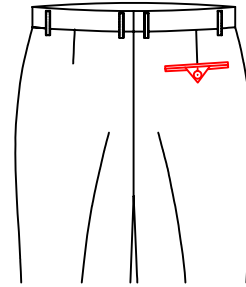

T-32D6

Double besom right back pocket with triangle button and buttonhole, no left back pocket

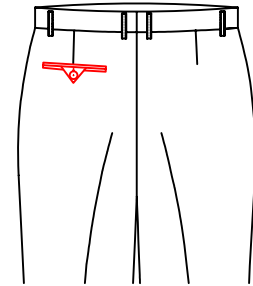

T-32D7

Double besom left back pocket with triangle button and buttonhole, no right back pocket

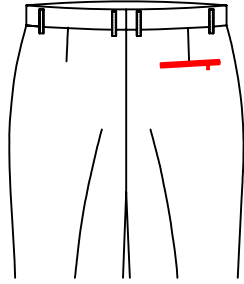

T-32D8

Only right back
besomzipper pocket ,
no left back pocket

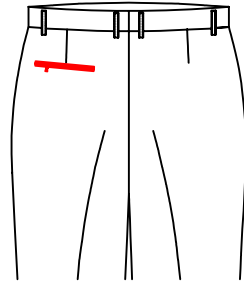

T-32D9

Only left back
besomzipper pocket ,
no right back pocket

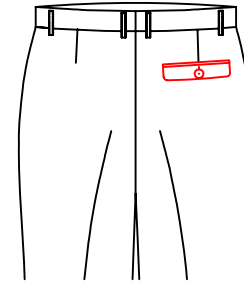

T-32E3

Only right back pocket,
with standard flap
and button ,no
left back pocket .

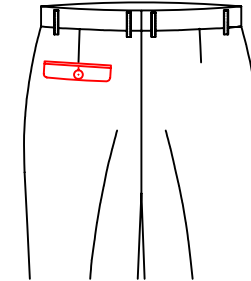

T-32E4

Only left back pocket,
with standard flap
and button ,no
right back pocket .

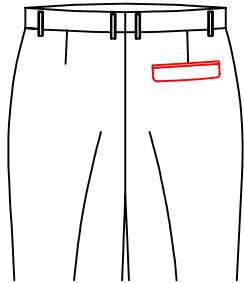

T-32E1

Only standard flap
left back pocket ,
no right back pocket .

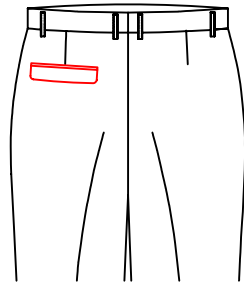

T-32E2

Only standard flap
left back pocket ,
no right back pocket .

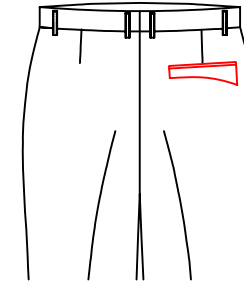

T-32E5

Only right back
pocket with slant
flap, no left back pocket

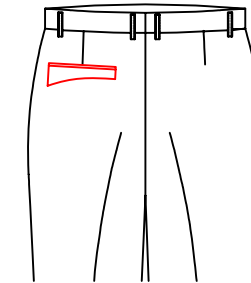

T-32E6

Only left back pocket
with slant flap,
no right back pocket

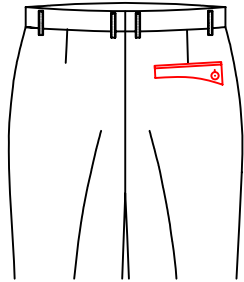

T-32E7

Only right back pocket with slant flap and button through , no left back pocket

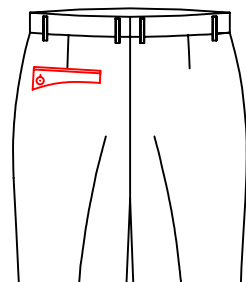

T-32E8

Only left back pocket with slant flap and button through , no right back pocket

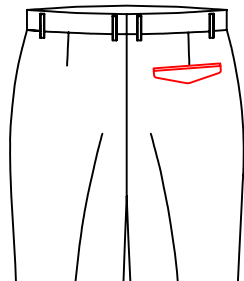

T-32E9

Only flap right back pocket , no left back pocket

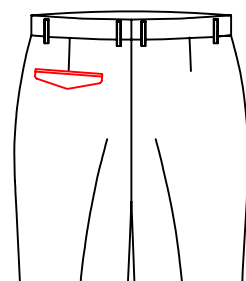

T-32F1

Only flap left back pocket , no right back pocket

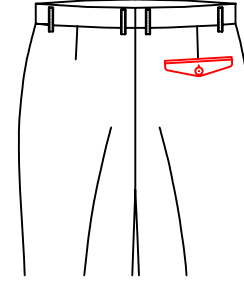

T-32F2

Only flap right back pocket with button , no left back pocket

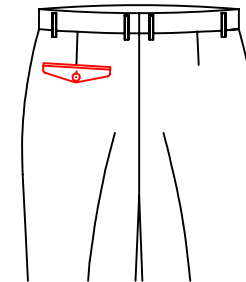

T-32F3

Only flap left back pocket with button , no right back pocket

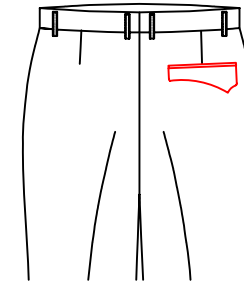

T-32F4

Only half wing flap right back pocket, no left back pocket

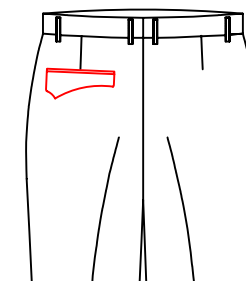

T-32F5

Only half wing flap left back pocket, no right back pocket

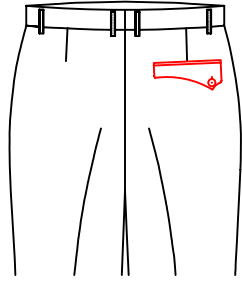

T-32F6

Only half wing flap
right back pocket
with button through,
no left back pocket

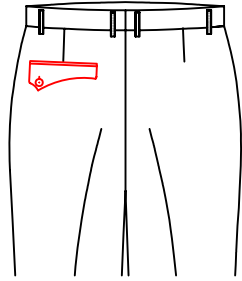

T-32F7

Only half wing flap right
back pocket with button
through, no left back pocket

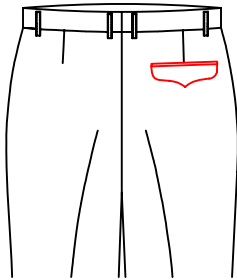

T-32F8

Only pointed flap
right back pocket ,
no left back pocket

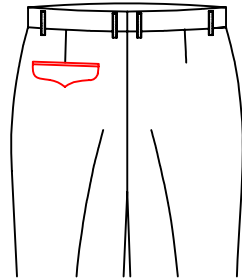

T-32F9

Only pointed flap
left back pocket ,
no right back pocket

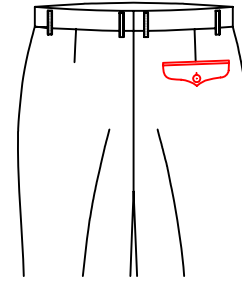

T-32G1

Only pointed flap right
back pocket with button ,
no left back pocket

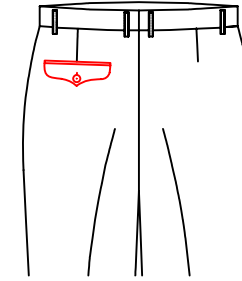

T-32G2

Only pointed flap
left back pocket
with button , no
right back pocket

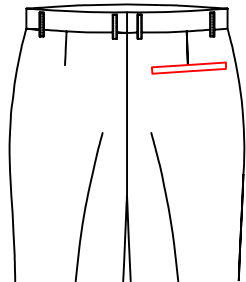

T-32P3

Only welt right back pocket
no left back pocket

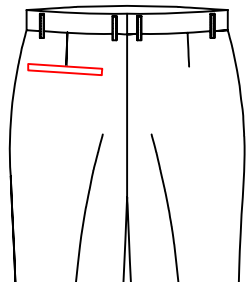

T-32P4

Only welt left back pocket
no right back pocket

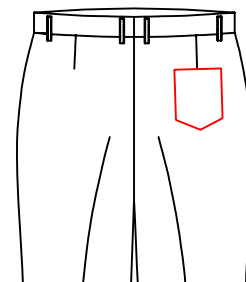

T-32G5

Only point patch right back
pocket , no left back pocket

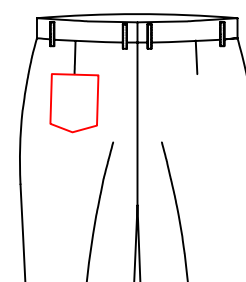

T-32G6

Only point patch left back pocket
no right back pocket

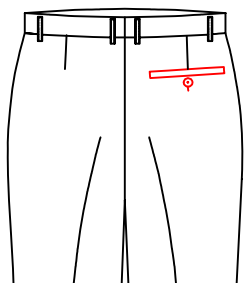

T-32G3

Only welt right back pocket
with button,no left back pocket

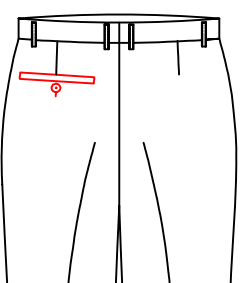

T-32G4

Only welt left back pocket
with button,no right back pocket

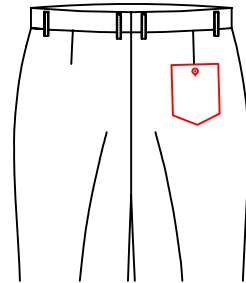

T-32G7

Only point patch right back pocket
with button,no left back pocket

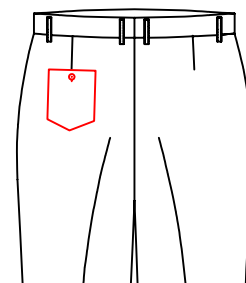

T-32G8

Only point patch left back pocket
with button,no right back pocket

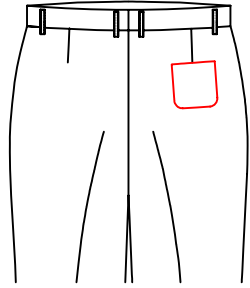

T-32G9

Patch right back pocket with circular bead, no left back pocket

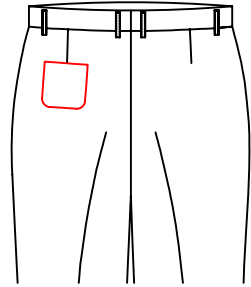

T-32H1

Patch left back pocket with circular bead, no right back pocket

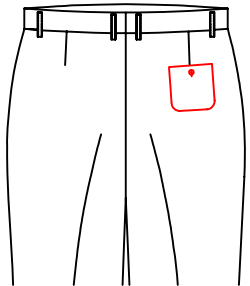

T-32H2

Patch right back pocket with circular bead button & buttonhole, no left back pocket

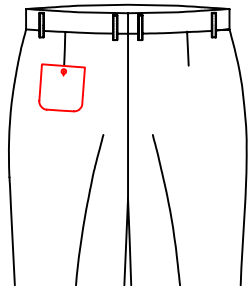

T-32H3

Patch left back pocket with circular bead button & buttonhole, no right back pocket

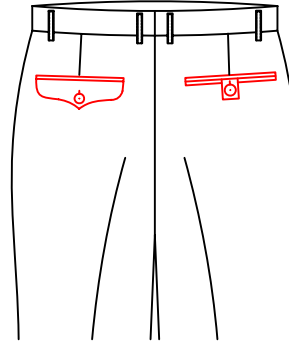

T-321R

double besom with square tab with button right back pocket / pointed flap with button left pocket

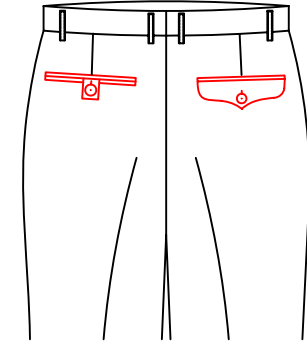

T-321E

double besom with square tab with button left back pocket / pointed flap with button right pocket

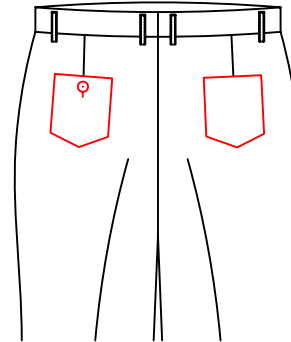

T-32P0

Left back patch pocket with pointed flap and w/button right back patch pocket with pointed flap

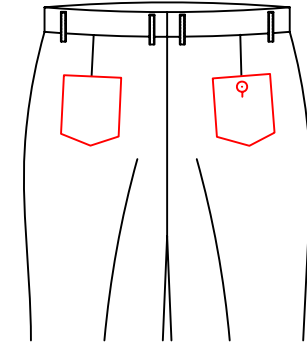

T-32P5

Point patch right back pocket with button through / point patch left back pocket

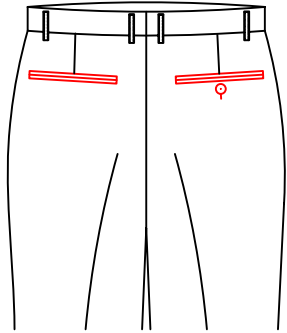

T-320A

Double besom back pocket

button and buttonhole on right pocket

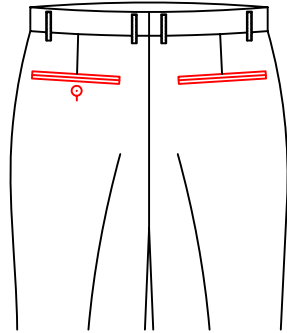

T-320B

Double besom right pocket

button /Double Besom Left pocket w/button

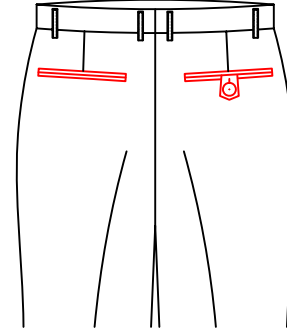

T-320C

double besom left back pocket

/double besom right back pocket
with pointed tab and button through

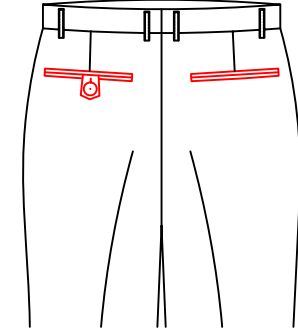

T-320D

double besom right back pocket

/double besom left back pocket
with point tab and button

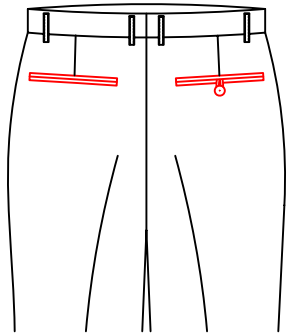

T-32H4

double besome righ back pocket

with loop and buttons

/double besome left back pocket

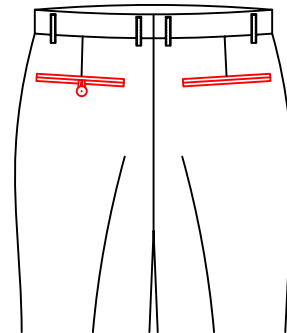

T-32H5

Double besom with tab

and button left back pockets

\double besom right back pocket

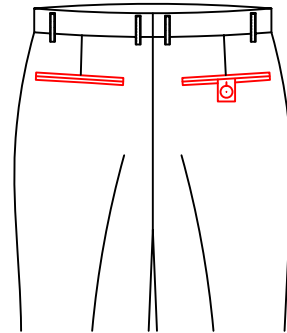

T-32B6

double besom left back pocket

/double besom right back pocket
with square tab and button through

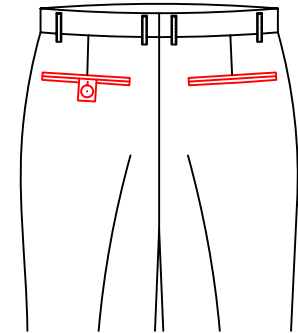

T-32B7

double besom right back pocket

/double besom left pocket
with square tab and button through

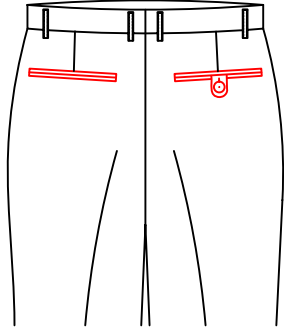

T-32B2

double besom left back pocket
/double besom&round tab right
back pocket with button and button hole

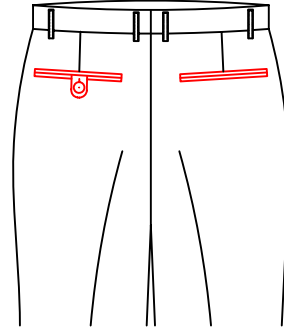

T-32H6

Double besom right pocket
/Double besom left pocket w round tab
/button&buttonhole

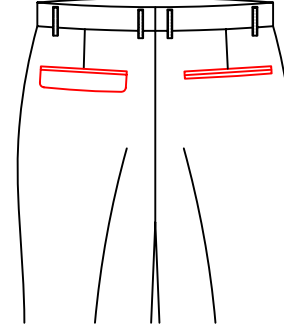

T-32H9

double besom right back pocket
/standard flap left back pocket

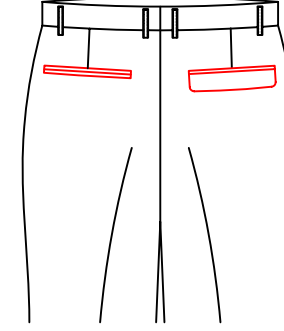

T-32J1

double besome left pocket
/standard flap right t back pocket

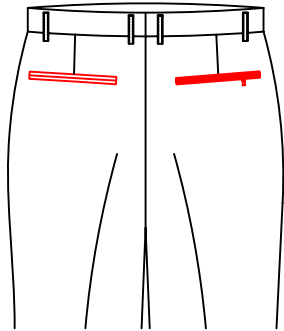

T-32H8

double besome left pocket
/zipper right back pocket

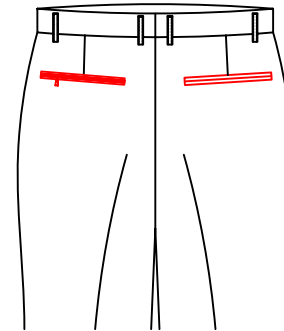

T-32H7

double besome right pocket
/diamond left back pocket
with button and button hole

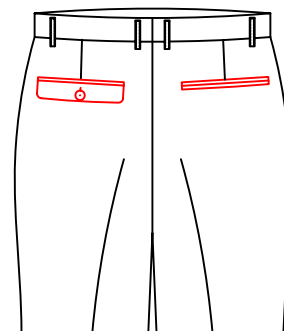

T-32J2

double besome right pocket
/standard flep left back pocket
with button and hole

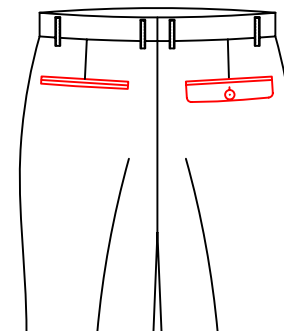

T-32J3

double besome left pocket
/standard flap right t back pocket

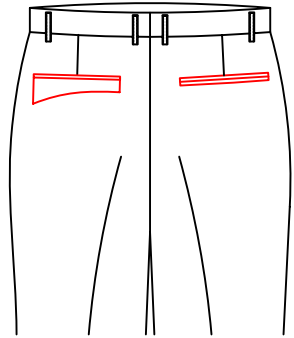

T-32J4

double besome right pocket/
knife flap left back pocket

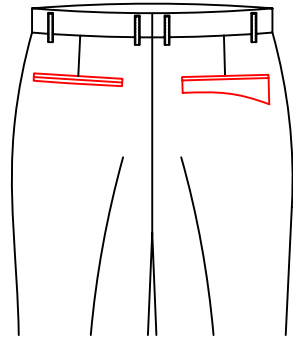

T-32J5

double besome left pocket/
knife flap right back pocket

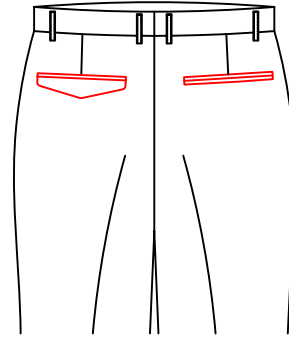

T-32J8

double besome right pocket/
diamond left back pocket

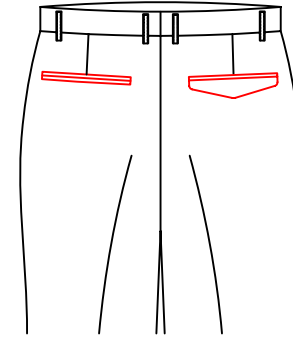

T-32B3

double besom left back pocket /
diamond flap right back pocket

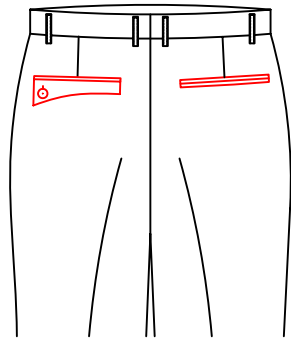

T-32J6

double besome right pocket/
knife flap left back pocket
with button and hole

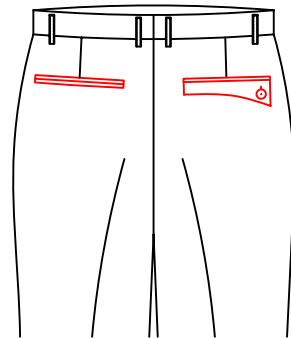

T-32J7

double besom right back pocket /
Slant flap left back pocket with
button and button hole

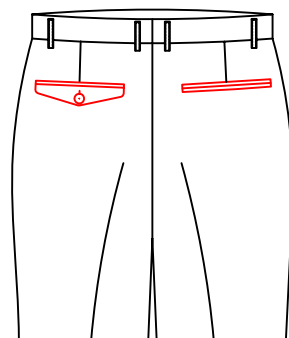

T-32J9

double besome right pocket/
diamond left back pocket

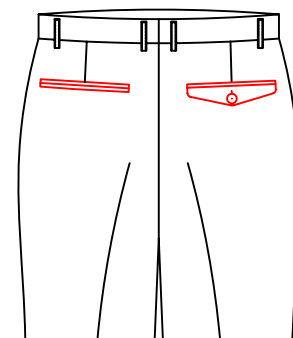

T-32K1

double besome left pocket/
diamond right back pocket

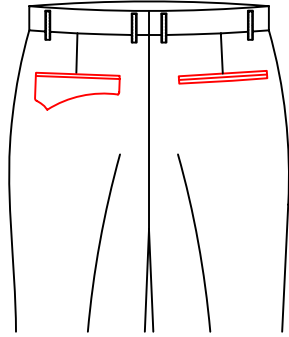

T-32K2

double besome right pocket
half pointed left back pocket

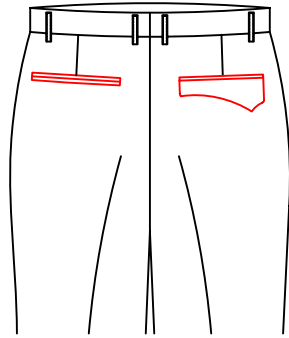

T-32K3

double besome left pocket
half pointed right back pocket

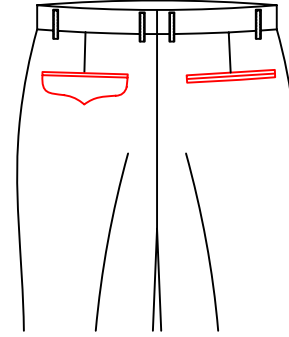

T-32K6

double besome right pocket
pointed flap left back pocket

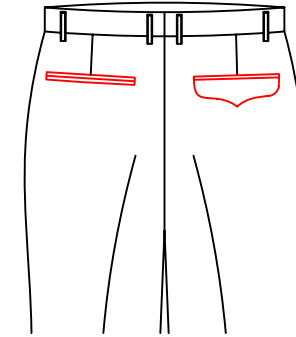

T-32K7

double besome left pocket
pointed flap right back pocket

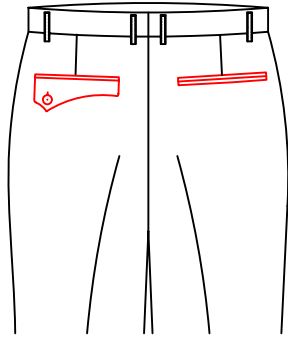

T-32K4

double besome right pocket
half pointed flap left back pocket

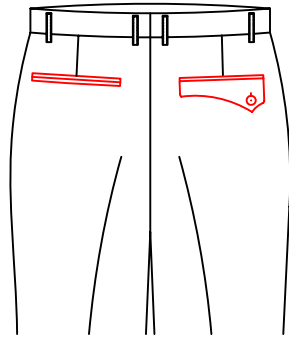

T-32K5

double besome left pocket
5cm under waist and
mouth width is 7cm

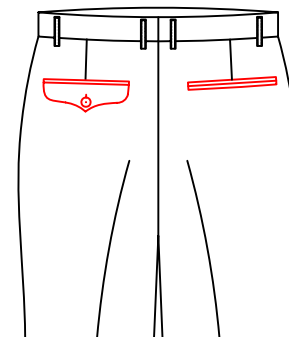

T-32K8

double besome right pocket
pointed left back pocket
with button and hole

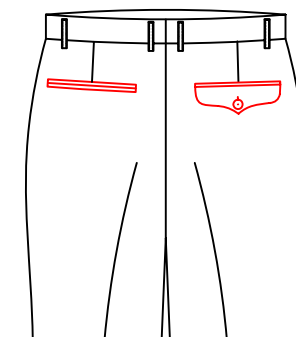

T-32K9

double besom left back pocket
right back pocket with
wing flap and button

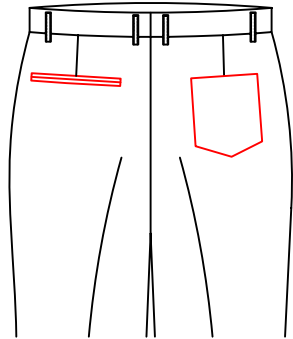

T-32P6

double besom left back pocket
Point patch right back pocket

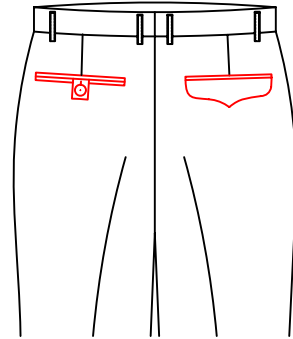

T-321T

double besom with square tab with
button right back pocket
pointed flap left pocket

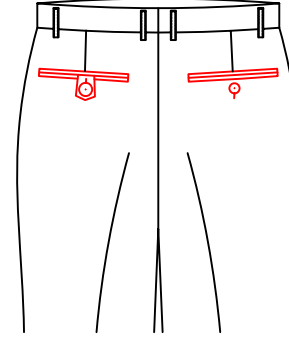

T-32B4

double besom with button pocket
double besom pocket with pointed loops
with button left pocket

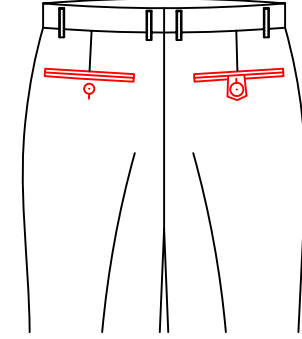

T-32L3

double besom with button left
back pocket/double besom pocket
with pointed loops with button

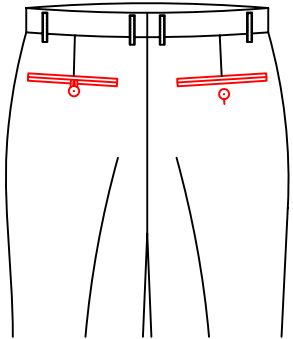

T-32L1

double besom with button right
back pocket/double besom pocket
with loop and buttons

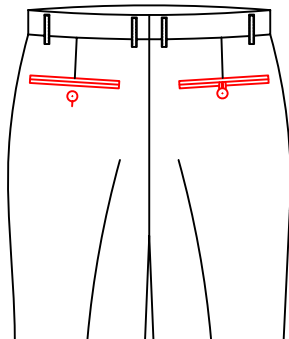

T-32L2

double besome with button
right back pocket with loop
and buttons/double besome left
back pocket

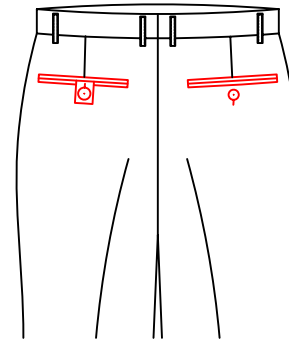

T-32L4

double besom with button
right back pocket/double besom
back pocket with square tab and
button through

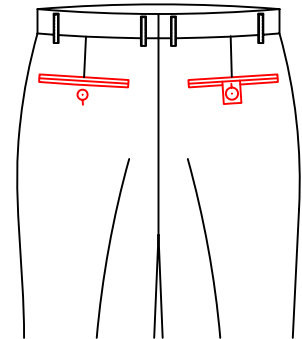

T-32L5

double besom with button
left back pocket /double
besom right back pocket
with square tab and button through

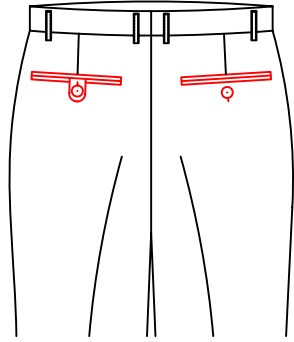

T-32L6

double besom right back pocket with button and button hole
double besom left back pocket with round tab and button

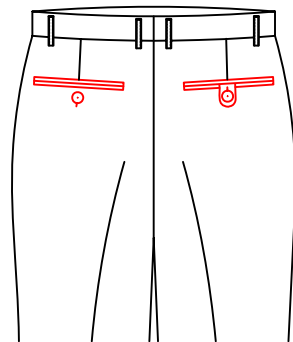

T-32L7

double besom left back pocket with button and button hole
double besom right back pocket with round tab and button

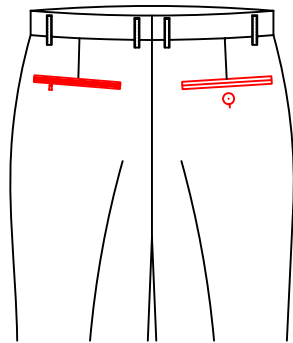

T-32L8

double besom with button right back pocket/zip left pocket

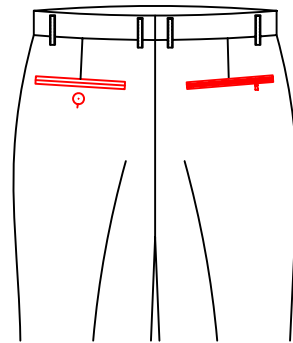

T-32L9

double besom with button left back pocket/zip back right pocket

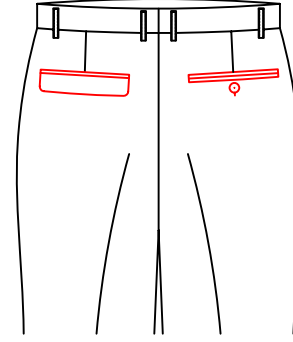

T-32M1

double besom right back pocket with button and button hole
standard flap left back pocket

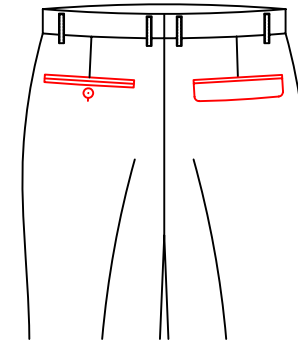

T-32M2

double besom with button left back pocket/standard flap right back pocket

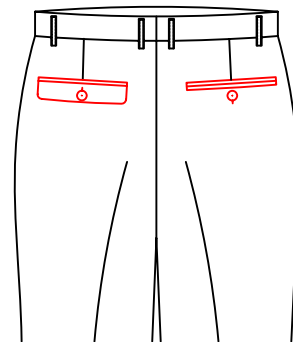

T-32M3

double besom right back pocket with button and button hole /standard flap left back pocket with button and button hole

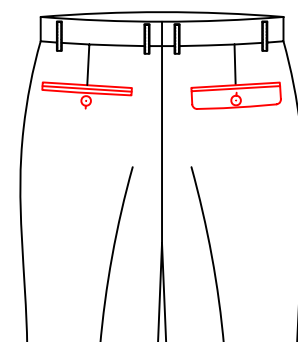

T-32M4

double besom left back pocket with button and button hole /standard flap right back pocket with button and button hole

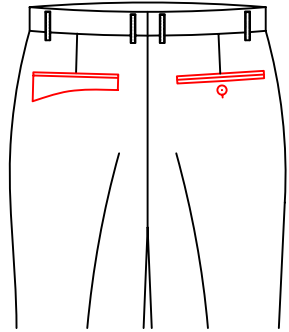

T-32M5

double besom right back pocket with button and button hole / Slant flap left back pocket

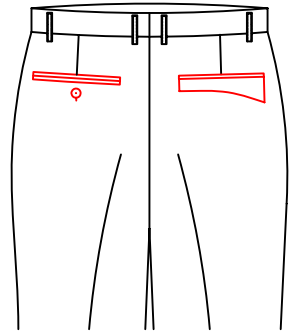

T-32M6

double besom left back pocket with button and button hole / Slant flap right back pocket

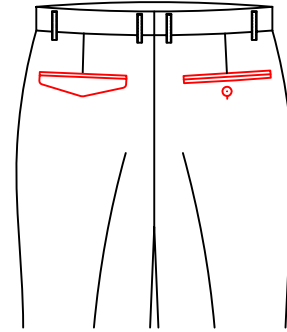

T-32M9

Left back pocket with point flap
Right back double besom pocket with button/buttonhole

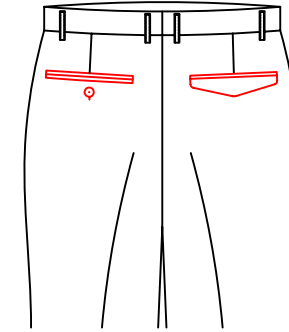

T-32B1

Right back pocket with diamond flap
Left back double besom pocket with button/buttonhole

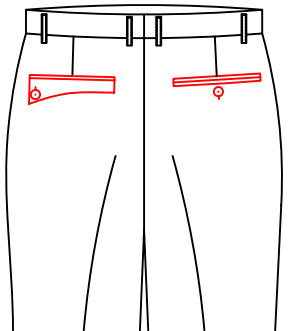

T-32M7

double besom right back pocket with button and button hole
left back pocket with slant flap and button through

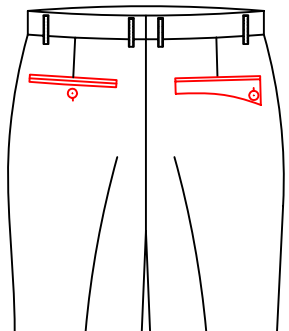

T-32M8

double besom left back pocket with button and button hole /
right back pocket with slant flap and button through

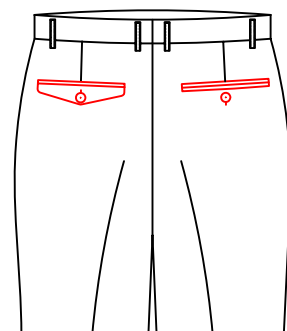

T-32N1

double besom right back pocket with button and button hole /
standard flap left back pocket

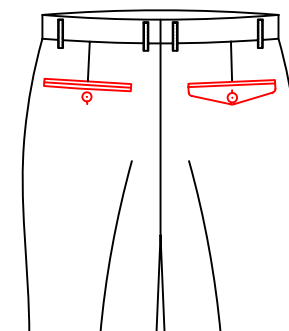

T-32N2

double besom left back pocket with button and button hole /
Point flap right back pocket with button and button hole

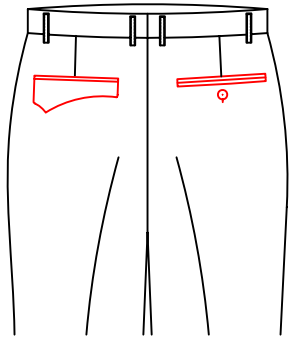

T-32N3

double besom with button
right back pocket/half pointed
flap right back pocket

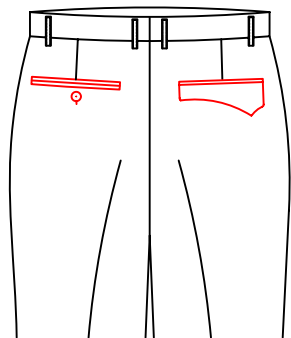

T-32N4

double besom with button
left back pocket/half pointed
flap right back pocket

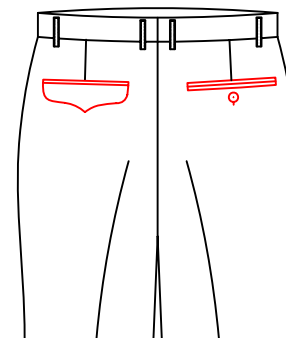

T-32N7

double besom right back pocket
with button and button hole /Wing
flap left back pocket

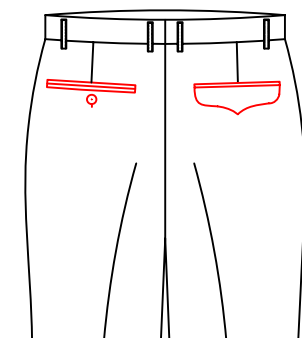

T-32N8

double besom left back pocket
with button and button hole /
Wing flap righth back pocket

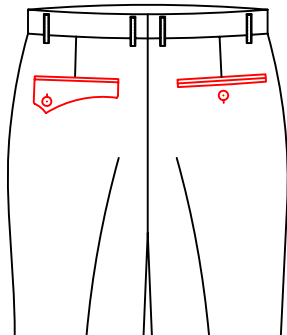

T-32N5

double besom right back pocket
with button and button hole /Half
wing flap left back pocket with
button and button hole

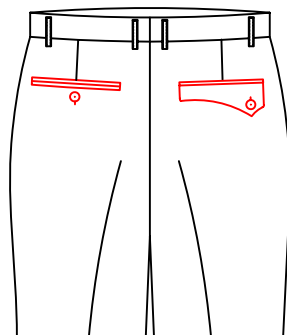

T-32N6

double besom left back pocket with
button and button hole /Half wing
flap right back pocket with button
through

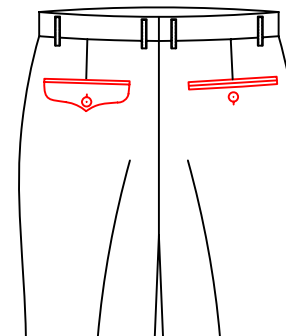

T-32N9

double besom right back pocket
with button and button hole /Wing
flap left back pocket with button
and button hole

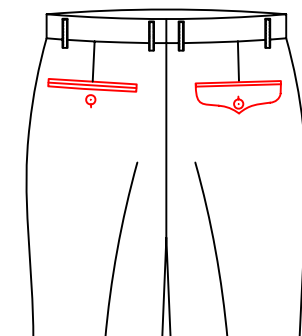

T-32P1

double besom left back pocket
with button and button hole /
Wing flap right back pocket
with button and button hole

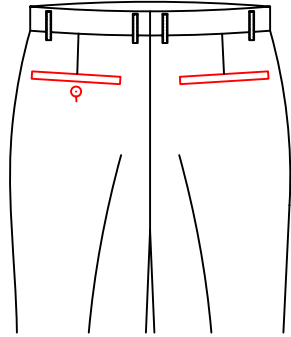

T-32B5

Welt right back pocket/
Welt left back pocket with button

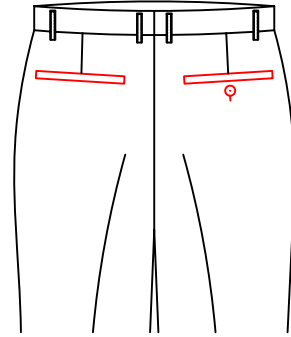

T-32P2

Welt left back pocket/
Welt right back pocket
with button through

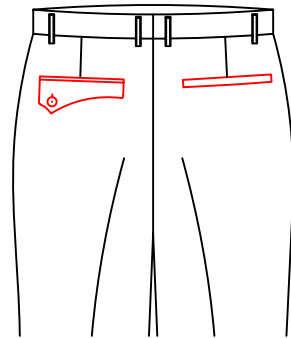

T-32U0

Right welt right back pocket\
half point flap w/button left
back pocket

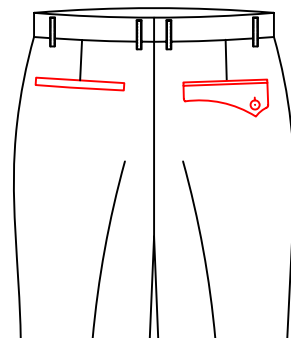

T-32U9

Welt left back pocket/
half wing flap right back
pocket with button

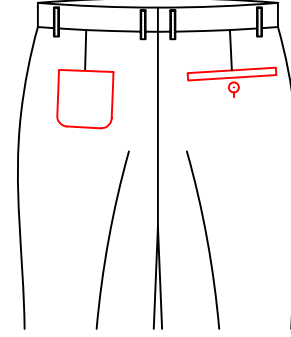

T-320H

right Beam pocket w/button\
round patch left back pocket

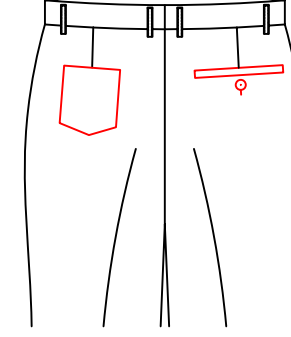

T-320J

right Beam pocket w/button\
point patch left back pocket

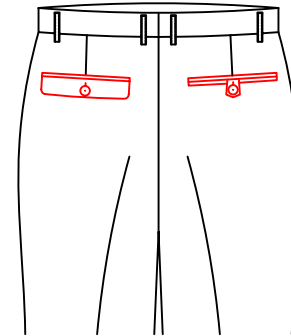

T-3216

Double besom with pointed tab
and button right back pockets\
flap with button left pocket

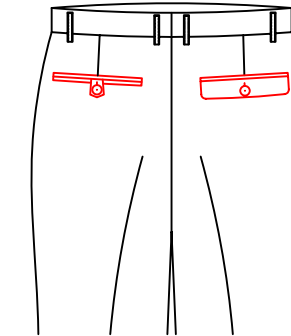

T-3217

Double besom with pointed tab
and button left back pockets\
flap with button righth pocket

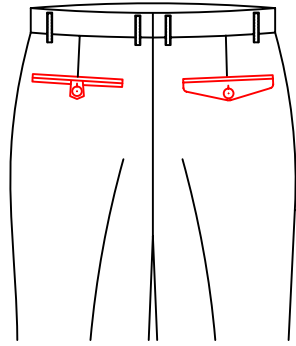

T-32P7

Double besom with pointed tab and button left back pockets\
Point flap right back pocket with button and button hole

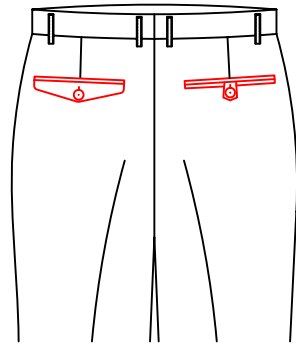

T-320K

Double besom with pointed tab and button right back pockets\
Point flap right back pocket with button and button hole

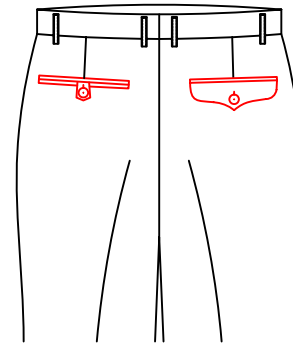

T-3219

Double besom with pointed tab and button left back pockets\
pointed flap with button right pocket

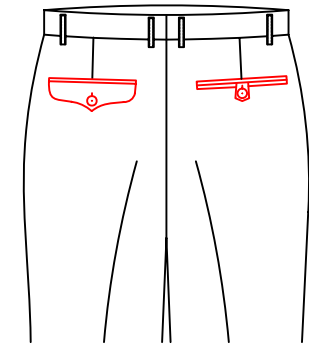

T-32P9

double besome pointed tab right back pocket with button and button hole /
Wing flap left back pocket with button

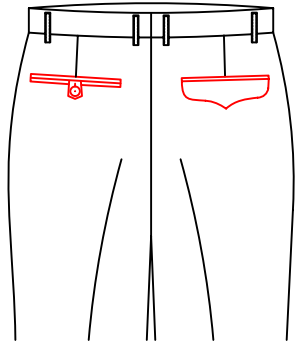

T-3218

Double besom with pointed tab and button left back pockets\
pointed flap right pocket

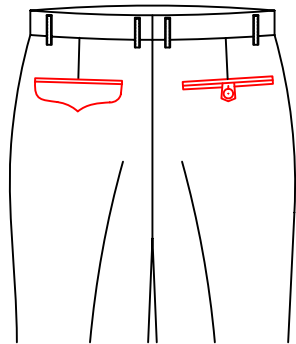

T-32P8

Double besom with pointed tab and button right back pockets\
pointed flap left pocket

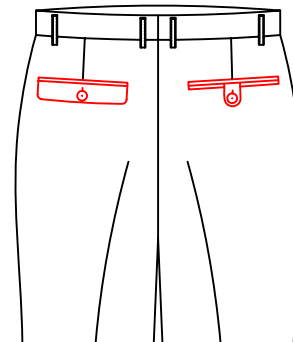

T-321A

Double besom with round tab and button right back pockets\
flap with button left pocket

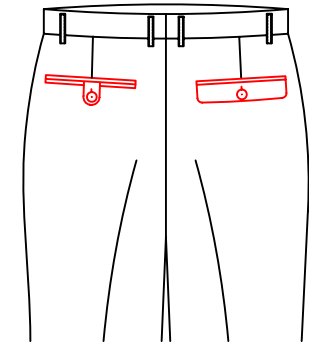

T-321S

Double besom with round tab and button right left pockets\
flap with button righth pocket

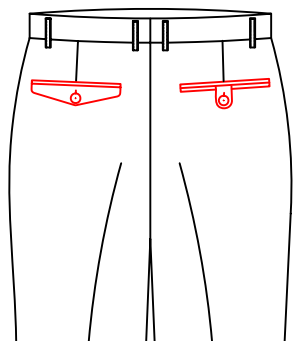

T-321F

Double besom with round tab and button right back pockets\
Point flap right back pocket with button and button hole

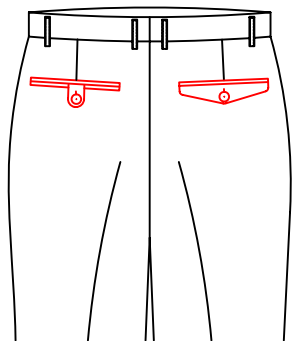

T-321D

Double besom with round tab and button right left pockets\
Point flap left back pocket with button and button hole

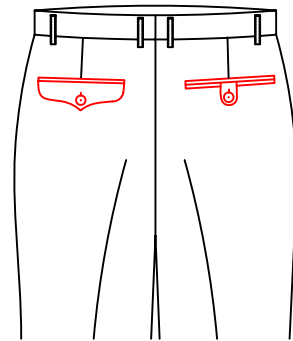

T-321J

Double besom with round tab and button right back pockets\
pointed flap left pocket

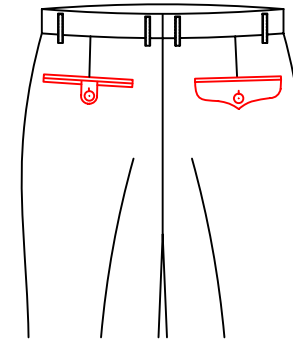

T-321K

Double besom with round tab and button right left pockets\
pointed flap with button right pocket

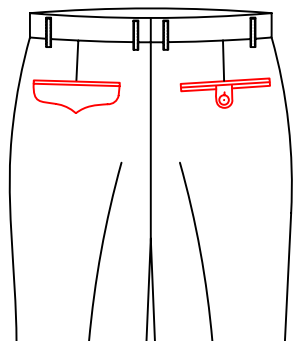

T-321G

Double besom with round tab and button right back pockets\
pointed flap left pocket

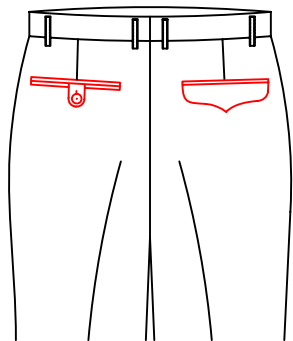

T-321H

Double besom with round tab and button right left pockets\
pointed flap left pocket

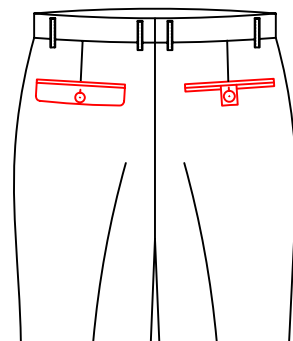

T-321M

double besom with square tab with button right back pocket\
flap with button left pocket

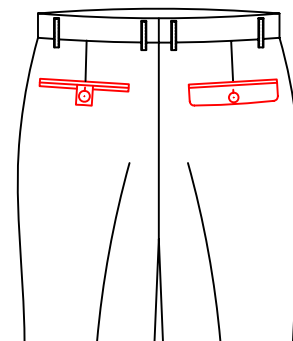

T-321N

double besom with square tab with button right left pocket\
flap with button right pocket

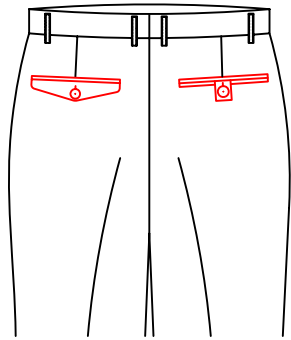

T-321U

double besom with square tab with
button right back pocket\Point flap
back pocket with button and
button hole

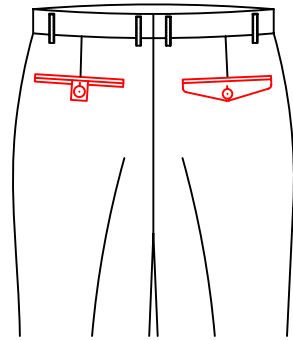

T-321P

double besom with square tab
with button left back pocket\
Point flap left back pocket with
button and button hole

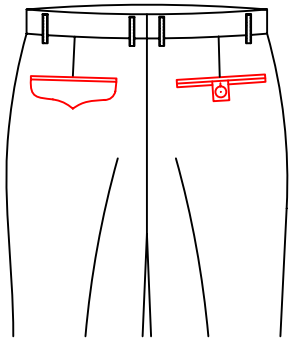

T-321Y

double besom with square tab
with button right back pocket\
pointed flap left pocket

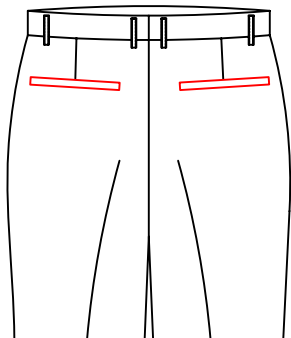

T-320Q

Single besom bidden buttonhole
back pocket with button

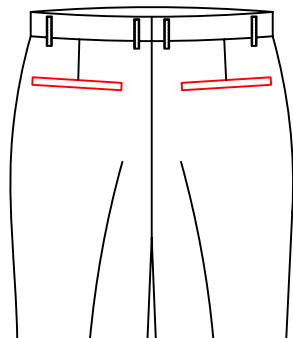

T-320U

Welt decorative back
pockets (no buttonholes)

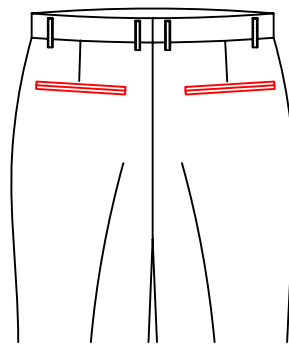

T-320L

Double besom hide button back pocket

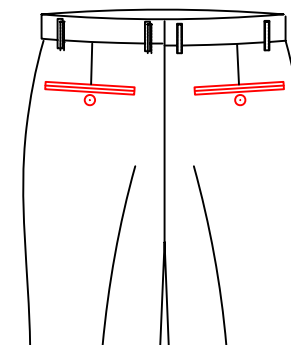

T-320V

double besome decorative
back pocket with buttons
and no buttonhole

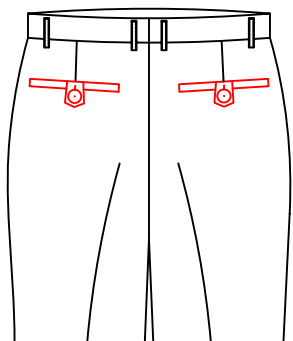

T-321C

Welt with pointed tab,
buttonholes and buttons
on back pockets

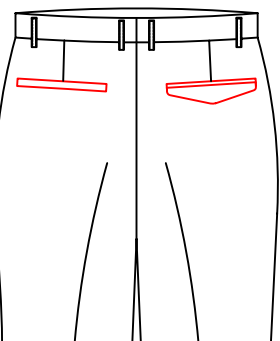

T-32NC

Welt left back pocket without
buttonholes/ Diamond flap for
right back pocket without
buttonholes and buttons

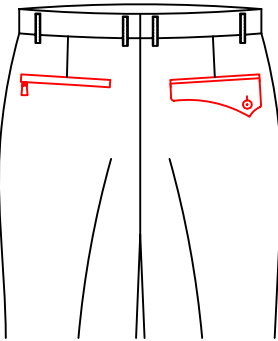

T-32UB

Welt left back pocket with
zipper and half wing flap
right back pocket with button
through

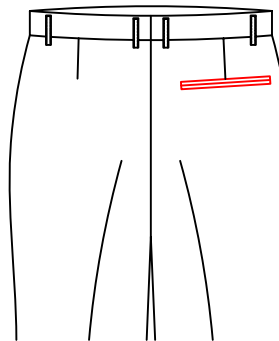

T-320N

Besom decorative right
back pocket(no buttonholes)
no left back pocket

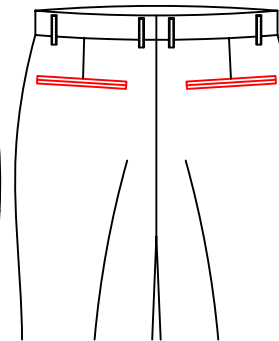

T-32PA

Besom with pointed tab,
buttonholes and buttons
on back pockets(hidden
buttons in the pockets)

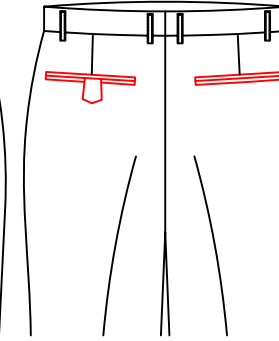

T-32LA

Besom with pointed tab,
no buttonholes and buttons
on left back pocket, besom
right back pocket(no buttonholes)

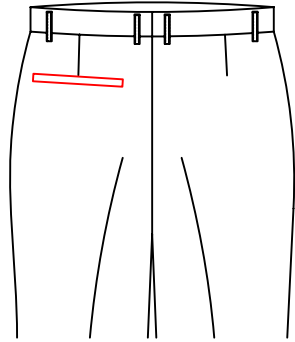

T-320S

Back pocket style:
only left back pocket sigle
besom hide button back pocket,
no right back pocket

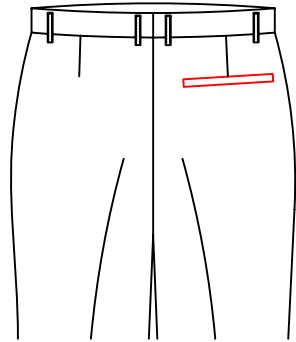

T-320R

Back pocket style:
only right back pocket
sigle besom hide button
back pocket,
no left back pocket

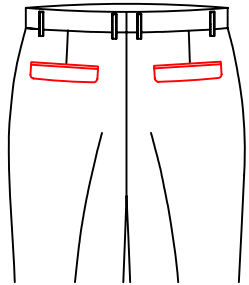

T-32CE

double besom adding standard
flap with button and button
hole back pocket(flap inside
with buttonhole,not been seen
from the flap face)

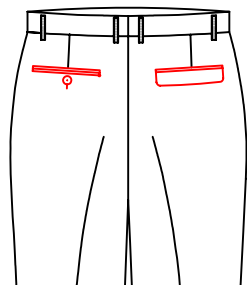

T-32MA

Back pocket style:
Double besom button
left back pocket,
standard flap,
button right back pocket

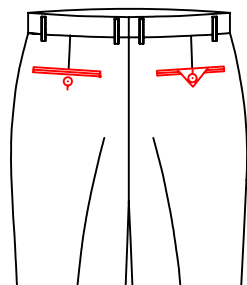

T-32MC

Hip pocket style:
Besom with with
buttonholes and buttons
for left back pocket
triangle tab, buttonholes
and buttons for right
back pocket (the height
of triangle is 4.5cm)

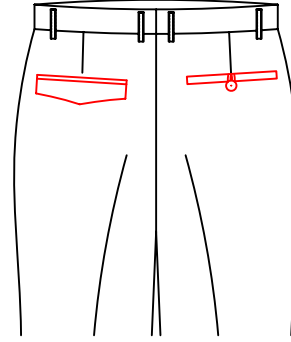

T-3225

Left double besom adding rhombic
flap cover anti-theft for back pocket
(flap bottom pant lining with button
and button hole),right pocket with
single besom adding button tab with
button for back pocket)

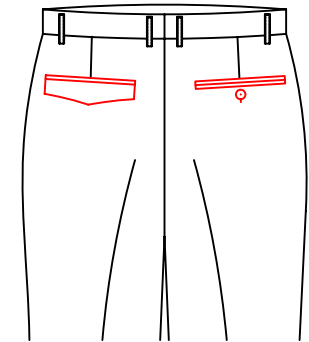

T-32MD

Hip pocket style:
Besome with buttonholes
and buttons for right
back pocket, also
diamond flap left
back pocket

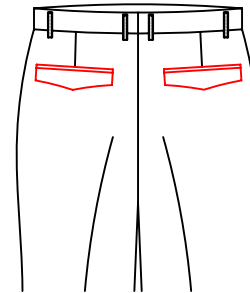

T-321B

Hip pocket style:
Back pocket with diamond
shape anti-theft pocket
cover(the lining of the
pocket cover is with button
and buttonhole)

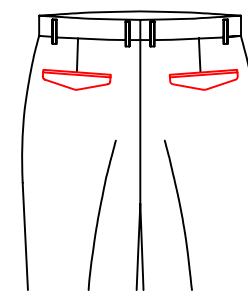

T-320T

Back pocket style:
Double besom with
tab and button back
pocket,diamond flap

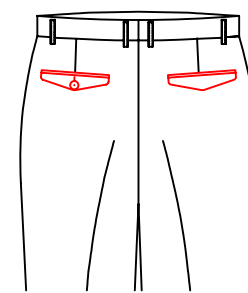

T-3238

Double besom with rhombic
flap adding button and
button hole for left back
pocket \\\ double besom
with rhombic flap right
back pocket (no button hole)

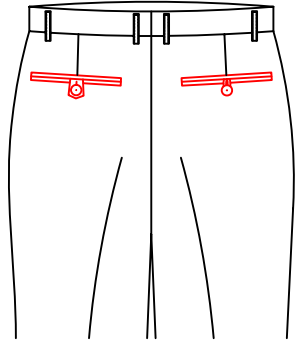

T-32UA

Hip pocket style:
Besom with pointed tab,
no buttonholes and buttons
on left back pocket, besome
right back pocket with loop
and buttons

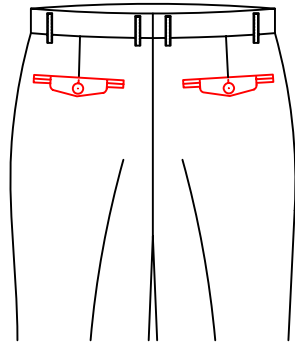

T-32CB

Back pocket style:
Double besom center add
small diamond flap button
back pocket, flap 2cm to pocket opening

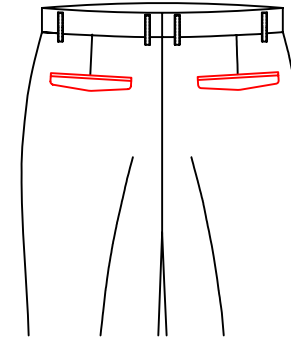

T-321L

Hip pocket style: Double besom
button through back pockets with
diamond flaps (invisible buttonhole
inside flaps)

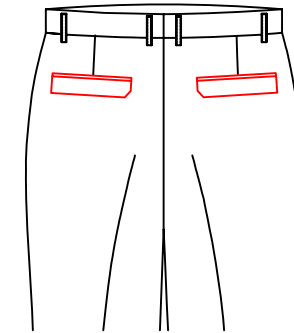

T-321Z

Hip pocket style:
Besome with five-pointed
flap for back pockets
(corner cut for mid of the back part)

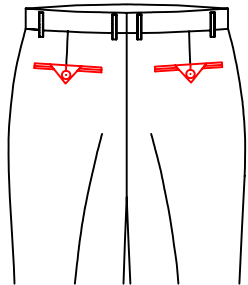

T-32DE

Hip pocket style:
Besom back pockets
with triangle flap,
buttonholes and buttons

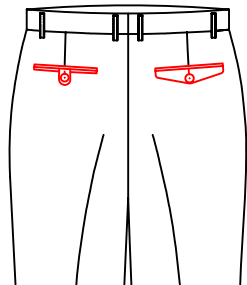

T-321D

Hip pocket style:
Double besom with round tab
and button right left pockets
flap left back pocket with button
and button hole

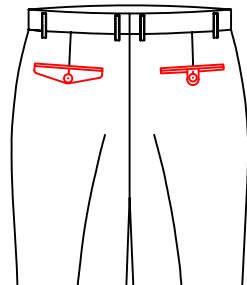

T-321F

Hip pocket style:
Double besom with
round tab and button
right back pockets
flap right back pocket
with button and button hole

Back pocket fabric style

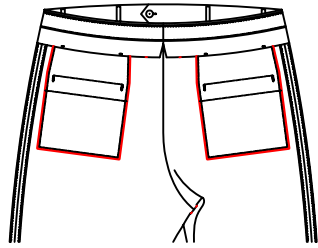

T-3267

Back pocket style: Back pockets using double layers pocket fabric

Pocket opening handmade knot

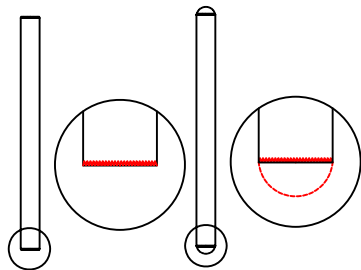

T-329C

hand made knot

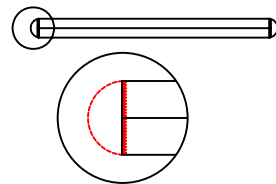

T-329E

Pocket opening handmade knot

back pocket depth

- T-3208 Hip pocket depth:<00FF>round pocketing<00FF>deepen 1.3cm for back pocket
- T-3209 Hip pocket depth:<00FF>round pocketing<00FF>deepen 2.5cm for back pocket
- T-32A3 Hip pocket depth:<00FF>round pocketing<00FF>deepen 3.8cm for back pocket
- T-32A4 Hip pocket depth:(square pocketing) back pocket deepen 1.3cm
- T-32A5 Hip pocket depth:(square pocketing) back pocket deepen 2.5cm
- T-32A6 Hip pocket depth:(square pocketing) back pocket deepen 3.8cm
- T-32A7 Hip pocket depth:Add 1.3cm on patch back pockets(depth)
- T-32A8 Hip pocket depth:Add 2.5cm on patch back pockets(depth)
- T-32A9 Hip pocket depth:Add 3.8cm on patch back pockets(depth)
- T-32B8 Hip pocket depth:(continuous round pocketing)\<00FF>back pocket deepen 1.3cm
- T-32B9 Hip pocket depth:(continuous round pocketing)\<00FF>back pocket deepen 2.5cm
- T-32B0 Hip pocket depth:(continuous round pocketing)\<00FF>back pocket deepen 3.8cm
- T-32Z7 Hip pocket depth:(continuous square pocketing)\<00FF>back pocket deepen 1.3cm
- T-32Z8 Hip pocket depth:(continuous square pocketing)\<00FF>back pocket deepen 2.5cm
- T-32Z9 Hip pocket depth:(continuous square pocketing)\<00FF>back pocket deepen 3.8cm

Back pocket size

- T-3261 back pocket specification:enlarge the hip pocket opening by 0.5cm
- T-3262 back pocket specification:enlarge the hip pocket opening by 1cm
- T-3263 back pocket specification:enlarge the hip pocket opening by 1.5cm
- T-3264 back pocket specification:enlarge the hip pocket opening by 2cm
- T-326A back pocket specification:0.5CM back patch pocket,width 0.5cm larger
- T-326B back pocket specification:0.5CM back patch pocket,width 1cm larger
- T-326C back pocket specification:0.5CM back patch pocket,width 1.5cm larger
- T-326D back pocket specification:0.5CM back patch pocket,width 2cm larger

Back pocket besom fabric

- T-325A the fabric for back pocket besom:Hip pocket besom with satin\|||||\<00FF>
- T-325B back pocket besom fabric:Pants back pockets splitting seam fabric with customer appointed-
- T-3258 back pocket besom fabric:Back pockets coustomer appointed fabric-
- T-325D back pocket besom fabric:Back pocket besom with reverse side of customer appointed fabric-
- T-325E back pocket besom fabric:back pocket seam thread and bottom material appointed by customers

back pocket bottom style

T-325P back pocket bottom style:0.1cm top stitch on hip pocket curtain

back pocket flap/tab

T-325H back pocket flap tab fabric: Pants back pocket tab with customer appointed fabric-

back pocket seal

T-3296 Sealing back pockets:Hinder baste hip pocket

back pocket seal style

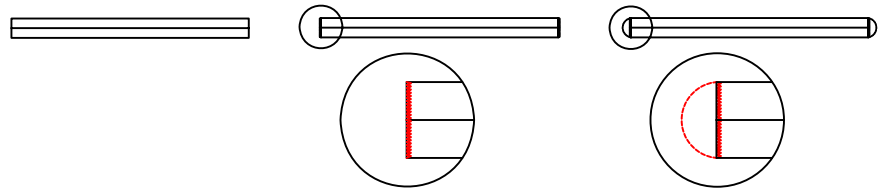

T-3290 Hip pocket seal style: Back pocket-No bartack
 T-3291 Hip pocket seal style: Hip pocket:I pocket edge
 T-3292 Hip pocket seal style: Hip pocket-D shape bar tack

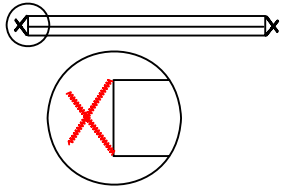

T-3293 Hip pocket seal style: Hip pocket:X pocket edge

button hole style

T-329A Eyelet buttonhole

T-329B Normal buttonhole

Placket,pocket opening Style

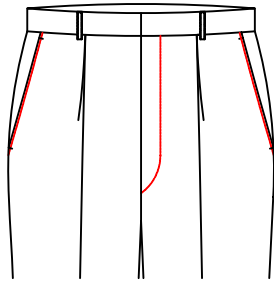

T-3300

△ Position:top stitch on the front placket

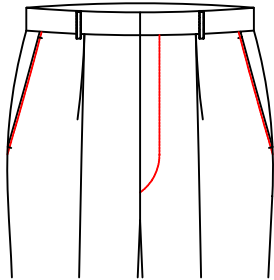

T-3305

placketyöopening handling style:thread color for front pocket and fly stitching with customer appointed-

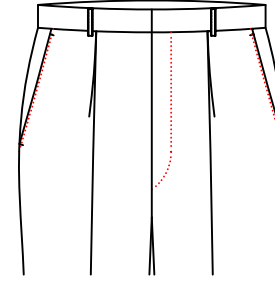

T-3301

Placketyöopening of poceks style:pic.stitch

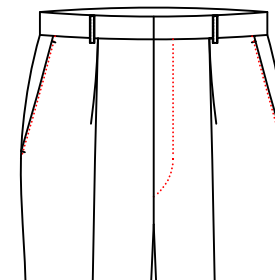

T-3306

placketyöopening handling style:

Placket Front

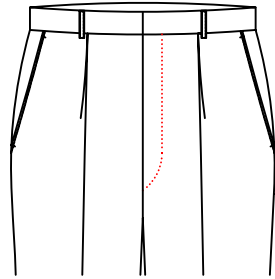

T-330A

placket front:big stitching for front

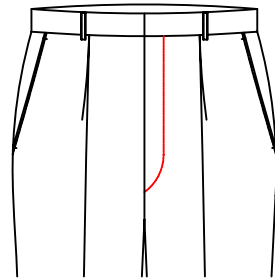

△ T-330B

placket front:
top stitching for front piece

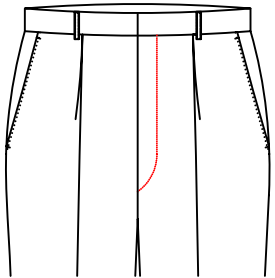

T-330C

placket front:pick sitch on front fly
with little needle distance

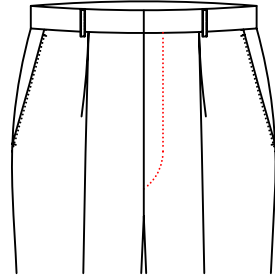

T-3308

front placket style:Front of suit for small
distance pic stitch with customer appointed thread-

Pic Sticking Around Hip Pocket



T-33H0

pic stiching around hip pocket:
0.15cm pic stitching around hip pocket

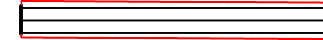

T-33H1

pic stiching around hip pocket:
0.3cm pic stitching around hip pocket



T-33H2

pic stiching around hip pocket:
0.3cm top stitching around hip pocket



T-33H3

pic stiching around hip pocket:
Large needle,0.3cm pic stitching
around hip pocket

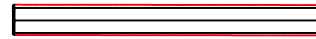

T-33H5

pic stiching around hip pocket:0.15cm top stitch on the outside of back pockets

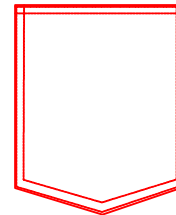

T-33H4

pic stiching around hip pocket:
0.1cm*0.7cm double top stitch for patched pocket opening and patched pocket

Pocket Piping Stitch Style



T-33G1

pocket piping pic stitch style:
pocket flap 0.15cm pic stitch



T-33G2

pocket piping pic stitch style:
pocket flap rough stitch, 0.15cm pic stitch

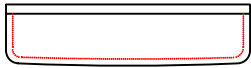

T-33G3

pocket piping pic stitch style:
pocket flap 0.6 pic stitch



T-33G4

pocket piping pic stitch style:
pocket flap rough stitch, 0.6cm pic stitch

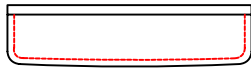

T-33G5

pocket piping pic stitch style:
Pocket flap with 0.6 top stitch



T-33G6

pocket piping pic stitch style:
Pocket flap with 0.1*0.7 top stitching

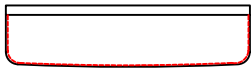

T-33G7

pocket piping pic stitch style:
0.15cm top stitching inside back pocket flap

Side Seam Style

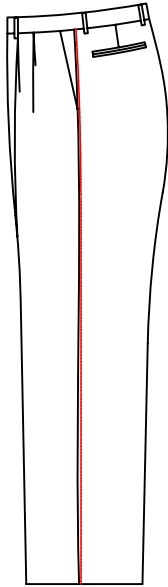

T-33W2

side seam style:
inseam big stitch 0.15cm pick stitching

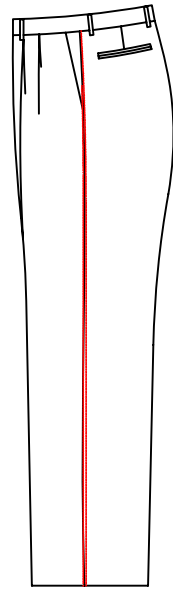

T-33W6

side seam style:
Flat seam with 0.15cm pic stitch
on both sides

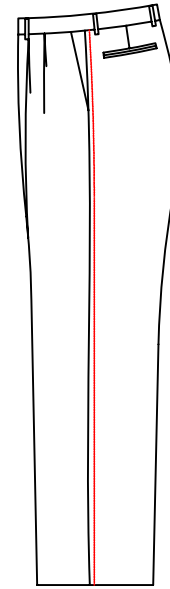

T-332L

side seam style:
Flat seam with 0.6cm pic stitch
on pant side seams

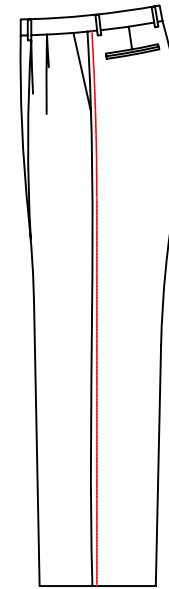

T-332H

side seam style:
Lap seam with 0.7cm,
wide pick stitch on pant side seams

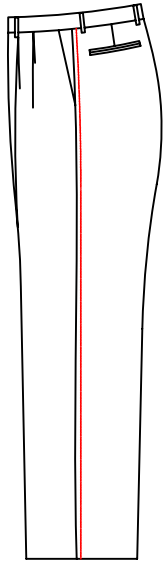

T-332F

Lap seam with 0.7cm
pick stitch
on pant side seams

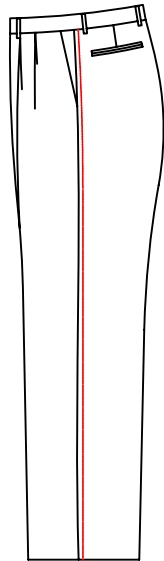

T-3325

Flat seam with 0.7cm
pick stitch
on pant side seams

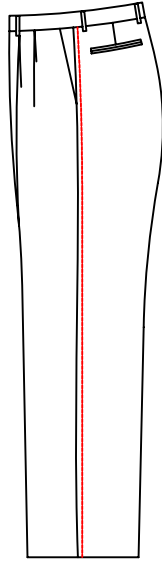

T-332C

Lap seam with 0.7cm
top stitch
on pant side seams

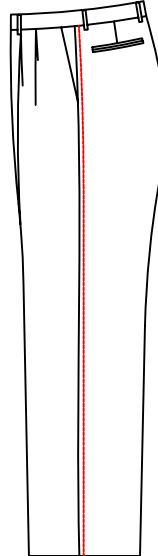

T-3322

Flat seam with 0.7cm
top stitch
on pant side seams

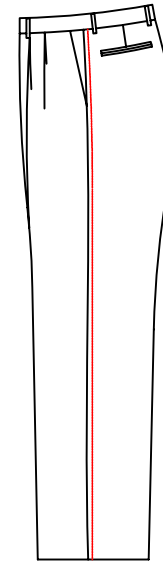

T-3327

Flat seam with 0.7cm
wide pick stitch
on pant side seams

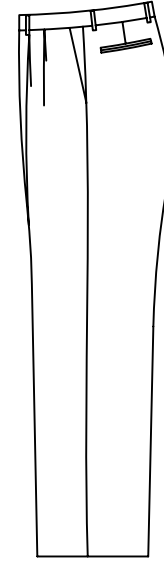

T-3310

Standard flat seam

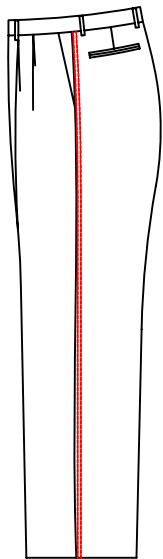

T-3323

Flat seam with 0.1*0.7cm double top stitch on pant side seams

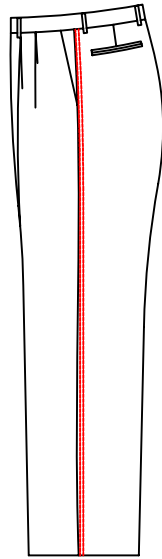

T-332D

Lap seam with 0.1*0.7cm double top stitch on pant side seams

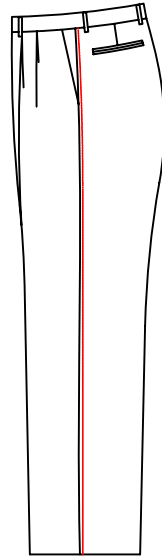

T-3324

Flat seam with 0.3cm pick stitch on pant side seams

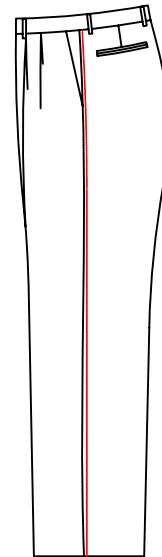

T-3326

Flat seam with 0.3cm wide pick stitch on pant side seams

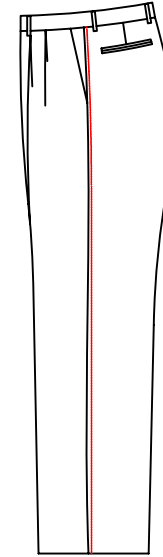

T-332E

Lap seam with 0.3cm pic stitch on pant side seams

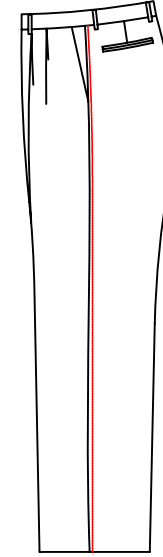

T-332G

Lap seam with 0.3cm pick stitch on pant side seams

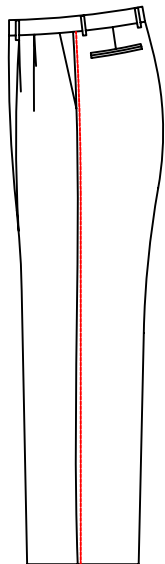

T-332B

Lap seam with
0.3cm top stitch
on pant side seams

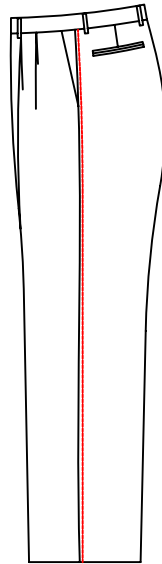

T-3321

Flat seam with
0.3cm top stitch
on pant side seams

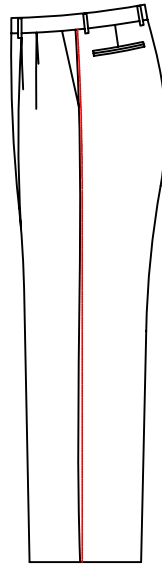

T-331N

Inseam back stitch
with big stitch
0.15cm pick stitching

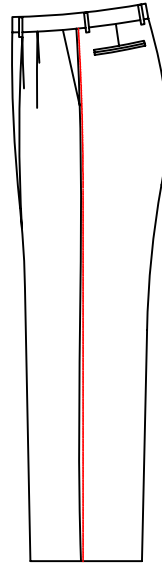

T-331M

Lap seam with
0.15cm pic stitch
on pant side seams

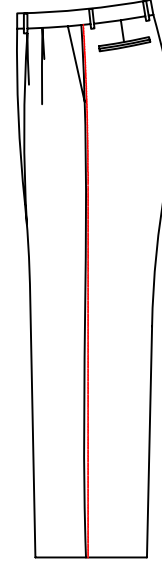

T-3312

Flat seam with
0.15cm pic stitch
on pant side seams

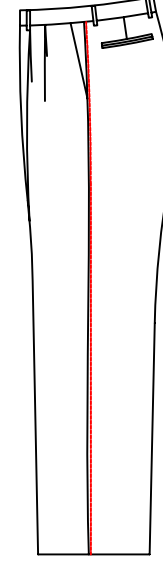

T-3311

Flat seam with
0.1cm top stitch
on pant side seams

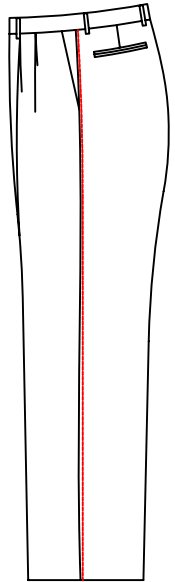

T-331K

Lap seam with
0.1cm top stitch
on pant side seams

The pic stitch/top stitch for back darts

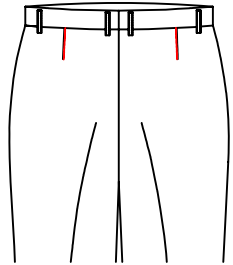

T-33Q1

0.15cm pic stitch on back darts

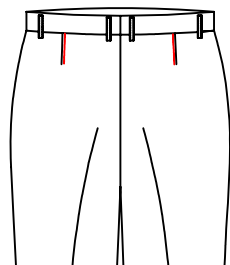

T-33Q2

0.6cm pic stitch on back darts

Sideseam stitching style

T-332J Side seam top/pick stitching appointed thread# -

Satin fabric

T-331B With plain satin

T-331J Customer appointed satin-

Waistband fabric

T-33A1 Satin waistband

T-33A2 Customer appointed waistband -

△ T-33AE Waistband using pant fabric -

T-33A6 Waistband with reverse side of customer appointed fabric-

T-33A9 Outside waistband with 1.5cm fabric, customer appointed the fabric-

T-33AG Waistband up and down center 1.2cm wide customer appoint fabric -

Satin Position

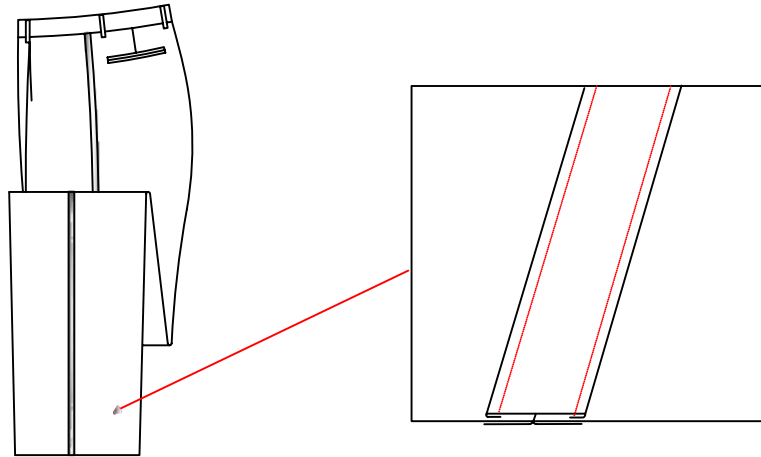

T-3313

Side seam with satin stripe (2.0cm width)

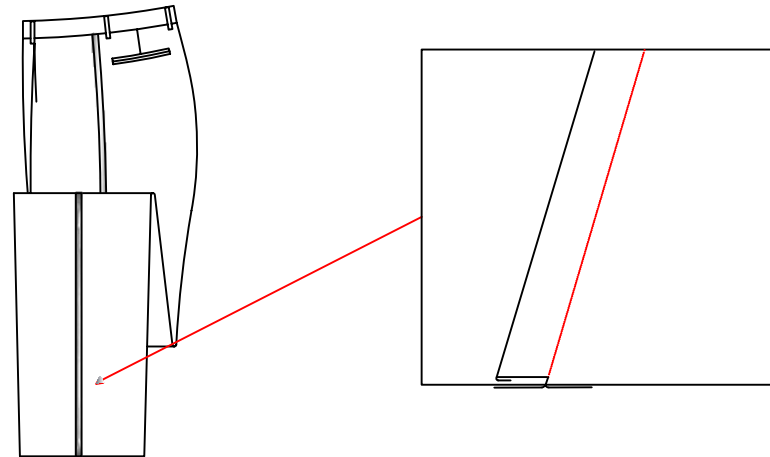

T-3314

Side seam with satin (1.2cm width)

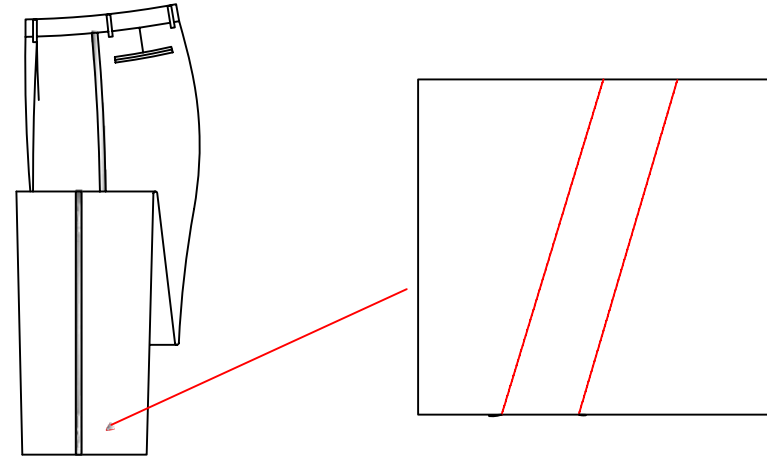

T-3315

Side seam with satin stripe (1.2cm width)

T-3316 Sideseam with 0.6cm satin

T-3318 Sideseam with 0.6cm satin

T-3319 Sideseam edge with customer appoint piping-

T-331E Sideseam with appointed fabric (1.2cm width/slice width 4.2m)

T-331F Sideseam with appointed fabric (1.2cm width/slice width 2.8m)

T-331G Sideseam with appointed fabric (1.2cm width/slice width 4.5m)

T-331H Sideseam with appointed piping (0.6cm width/slice width 3.3m)

T-331L Sideseam with appointed reverse fabric
(1.2cm width/slice width 2.8m)

T-331S Sideseam with 1.2cm wide body fabric(slice width 2.8m)



Belt loop style

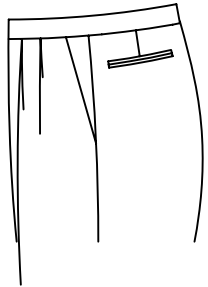

T-3329
No belt loop

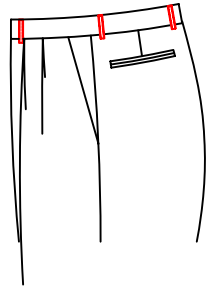

△ T-3330
Regular belt loops

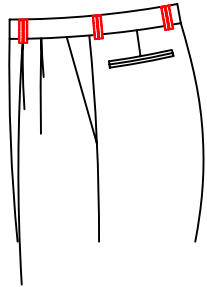

T-3331
Double belt loop

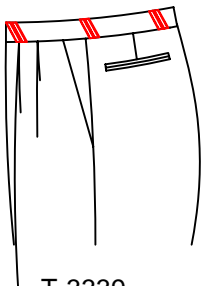

T-3339
Double slant belt loop

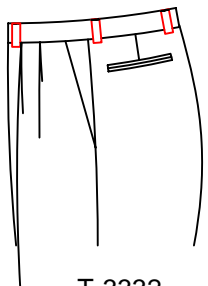

T-3332
Belt loop width
2.0CM

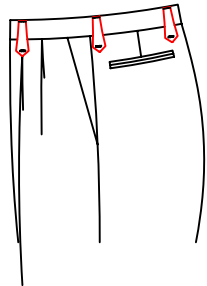

T-3333
Big head belt loop

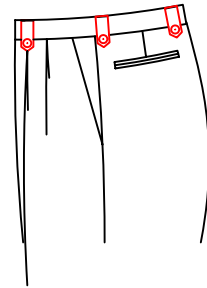

T-3334
Buttons on belt loop 2.0cm wide slant beltloop



T-3335
Double belt loop
only on front

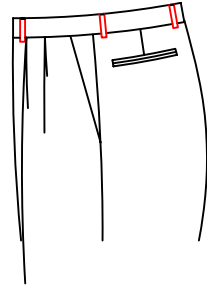
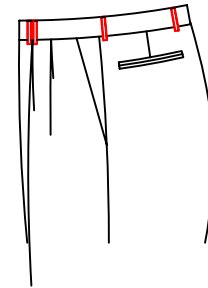

T-3337
Belt loop width:1.3cm

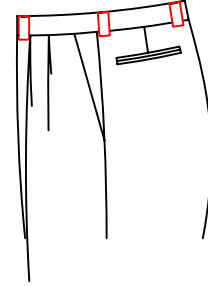

T-33D1
Belt loop width:3.8cm



T-3338
Belt loop width:3.8cm

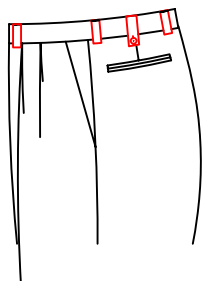

T-34H3

3.8cm width belt loop
(w/button through)
between back center seam
and side seams
2.0cm width belt loops
on front panel, side seam and back center seam

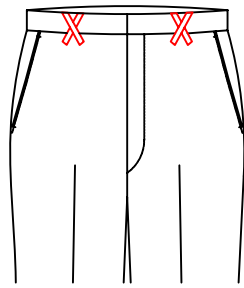

T-333E

X-style belt loops on front, The first belt loop
on front panel
with 3.0cm width.

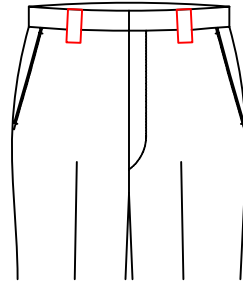

T-333D

Others are normal loops.

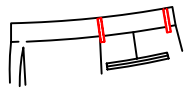

T-361F

2cm wide belt loop just for front
of pants and others
for normal belt loop



T-333F

3.2cm wide beltloop

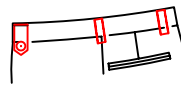

T-333W

Only Belt loop buckle
for front pant, others
for 2cm wide belt loop

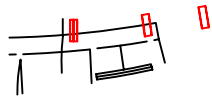

T-361E

Double belt loop just for
front of pants
and others for 2cm wide belt loop

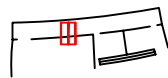

T-361D

2cm wide double belt loop
just for front of pants
and others for 2cm wide belt loop

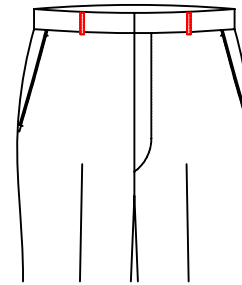

T-361B

Three belt-loops (two on front part, one on back seam)

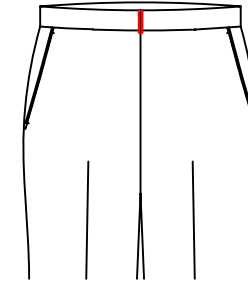

T-33B7

V shape on back middle loops(others regular)

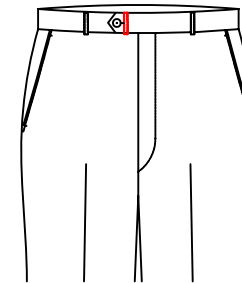

T-361C

Right waistband
with one belt loop
distance 2cm from flyer

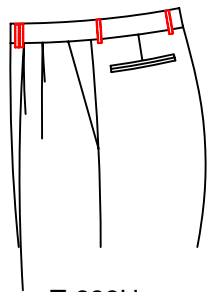

T-333H

Left front add double belt loop only, other beltloop as normal

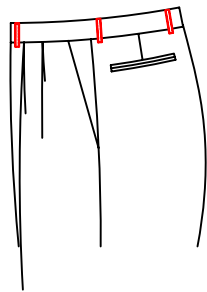

T-333J

Front beltloop fronted 1cm, other beltloop as normal

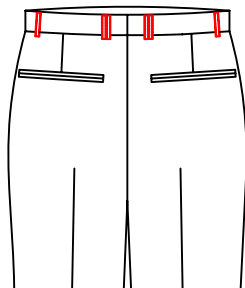

T-333K

Double belt loops on both sides of back crotch seam, other belt loops are normal

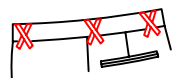

T-333M

X-shaped belt loop, 6 groups

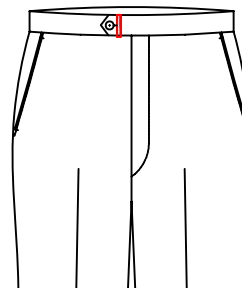

T-361N

Only one belt loop 2cm distance from front on right

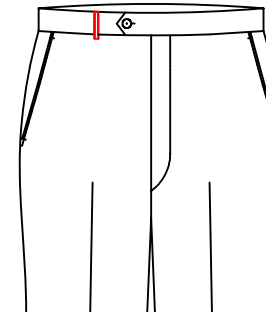

T-3618

Only one beltloop in right front waist, no other beltloops

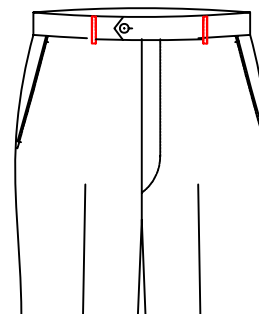

T-361S

Only one beltloop in right front waist, one belt on left front waist, no other beltloops

T-33B1 Normal belt loop not sewing on the trouser, delivery with garments

T-33BA Slant belt loop

Heel guard style

- T-33BB No heel guard
- T-3611 Heel guar
- T-3613 Heel guard is in the right back pocket
- T-3614 Add whole circle heel guard belt at pant bottom
- T-3616 The heel guard will be shipped with the pant
- T-361G Pant bottom add customer appointed heel guards
- T-361H Two pairs of heel guard, one on the bottom, and one shipped with the pant
- T-361L Add whole circle heel guard belt at pant bottom,finished ribbon
- T-361M Pant bottom add fabric label,edge add heel guards heel guards side point style
- T-361P Add whole circle heel guard belt for pant bottom, but directly shipped with the pant
- T-363N Add whole circle heel guard belt for pant bottom(Finished webbing), but individually shipped with the pant

Heel Guard Width

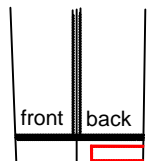

T-33B8
Heel guard width 3cm

Ironware Logo Tag

- T-33B9 Customer request pant ironware logo tag putting on the first left belt loop
- T-33BC Customer request pant ironware logo tag putting on the first right belt loop

Belt Loop Craft

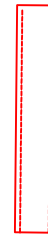

T-333A

△ 0.1CM double top
stitch on beltloop



T-333B

No top stitch
on belt loop



T-333C

0.1CM double top
stitch on beltloop,
customer appoint thread

Belt loop pic stitch style

- T-33G9 Customer appointed belt loop pic stitch

Beltloop Bartack Style

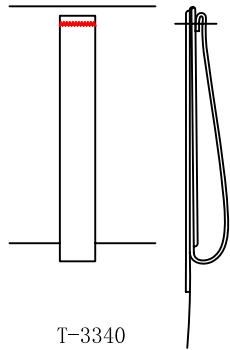

T-3340
△ Upper beltloop horizontal bartack

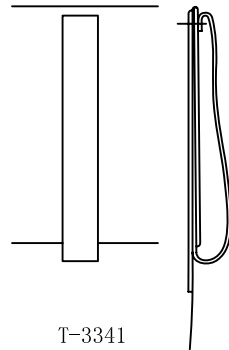

T-3341
Upper beltloop no bartack

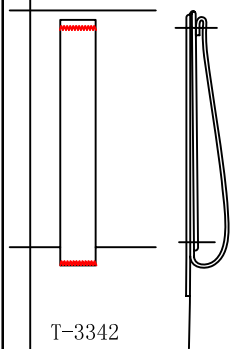

T-3342
Straight bartack on front and bottom of belt loop

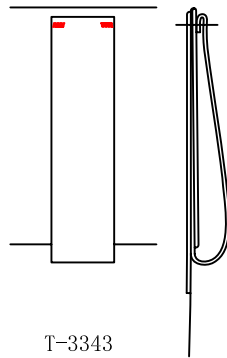

T-3343
Upper beltloop horizontal bartack on both side

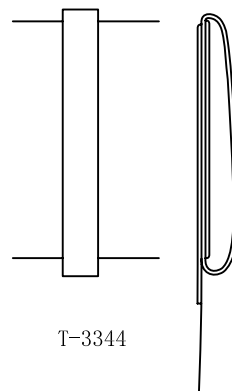

T-3344
belt-loop clipped inner the waist

Beltloop Fix Style

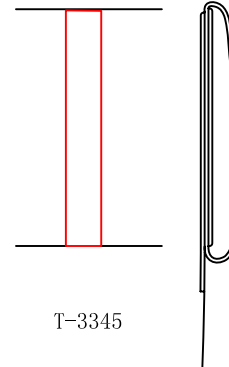

T-3345
Bottom beltloop in waist

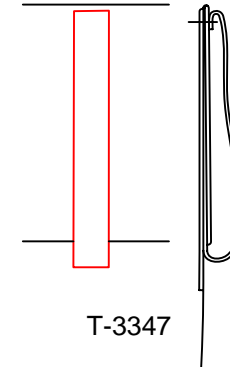

T-3347
△ Normal dropped beltloops

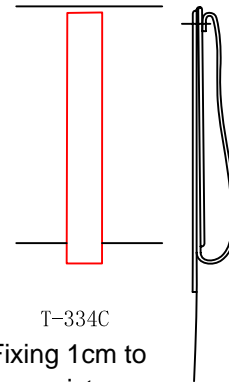

T-334C
Fixing 1cm to the waist seam, below the belt loops

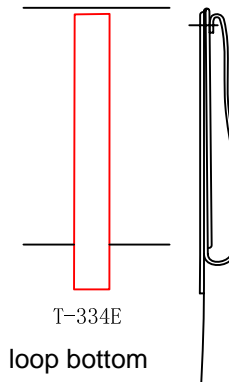

T-334E
loop bottom fixed 2cm under waistband seam

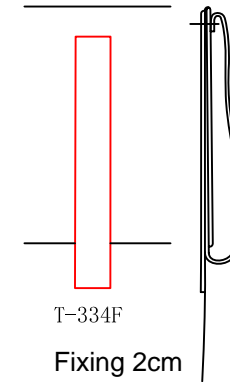

T-334F
Fixing 2cm above waist seam

Beltloop Fabric

T-3348 Customer request special fabric for belt loops-

Waist adjust style



△ T-3349
Standard waistband



T-3350
Movable and adjust waist



T-3356
Side Adjust tab



T-3358
Adjust buckle,
special buckle
for IMC



T-3351
Adjust buttons



T-335A
Adjust buttons
(three buttons)



T-3352
Adjust buckle,
buckle number

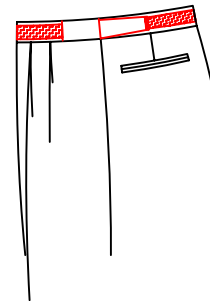

T-3357
Adjust elastic

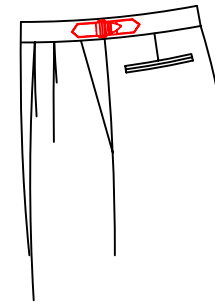

T-33T1
Dark color buckle
with beltloop

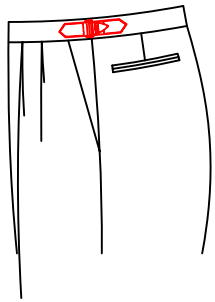

T-33T2

Waistband:silver adjust buckle-QZMAB01, add belt loop on the buckle

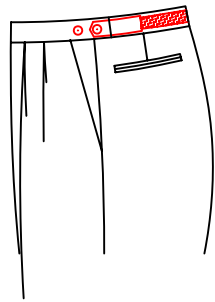

T-33T4

Waistband:Pointed adjust buttons



T-33T5

Waistband:Round adjust buttons

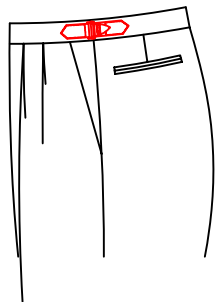

T-33TG

Adjustable pliers at the waist(with belt loop) customer appointed pliers

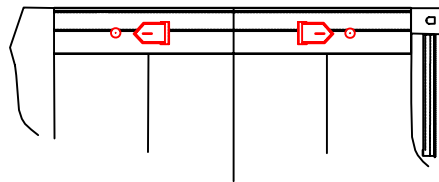

T-335H

Waistband:pointed inner waist adjust button

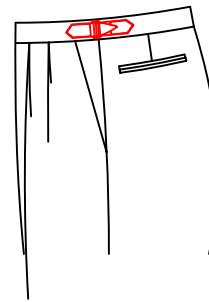

T-33T7

Waistband:Smoke Buckle Side Tabs on waistband-QZMAB02

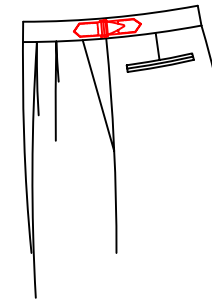

T-33T8

Waistband:Silver Buckle Side Tabs on waistband-QZMAB01

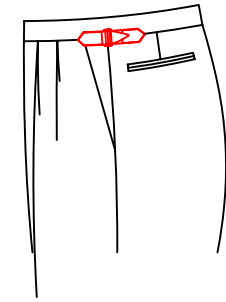

T-335J

Customer appointed waist adjustment style:Specify buckle on side seams



T-335N

Customer appointed waist adjustment style: waist 1/2 position separate,seam add 0.3cm fabric cover cord piping customer appoint

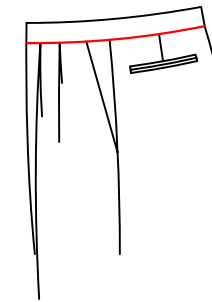

T-335R

customer appointed waist adjustment style:waist sideseam add 0.3cm fabric cover cord piping

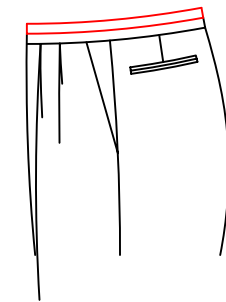

T-335N

customer appointed waist adjustment style: waist 1/2 position separate, seam add 0.3cm fabric cover cord piping customer appoint



T-33AK

Waistband:square adjust buckle
add beltloop on the buckle

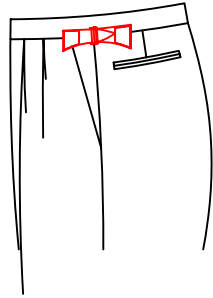

T-3376

Butterfly side waist adjustment
pliers(6.5cm before the side seam,
8cm behind the side seam, The top
is located at the center of the
waist, plier pic stitch length 3.8cm)



T-33F1

Dark adjustment pliers-QZMAB02
Adjust the pliers with belt
(adjust belt front short back
long, the net length of front
side seam is 4.5cm, and the
net length of back side seam
is 8.5cm)



T-33F2

Silver adjustment pliers-QZMAB01
Adjust the pliers with belt
(adjust belt front short back
long, the net length of front
side seam is 4.5cm,and the net
length of back side seam is 8.5cm)

Back center seam style

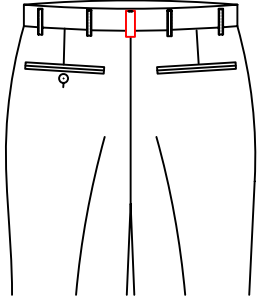

T-334D

Back center seam style:
2.5cm width belt loop
on back center seam

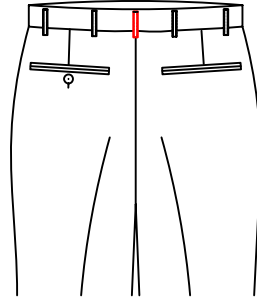

T-3346

Back center seam style:
Beltloop in Center back waistband

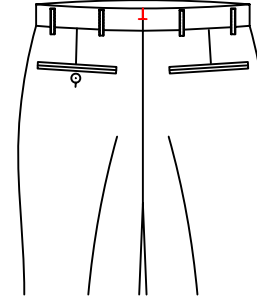

T-335B

Back center seam style:
I shape back
waist slotting
with flat bartack

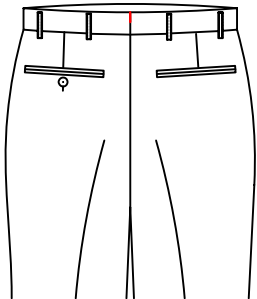

T-3353

Back center seam style:
I shape back
waist slotting

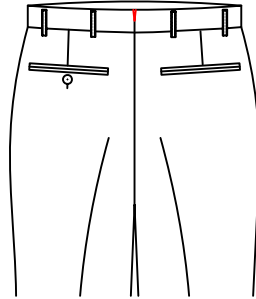

T-3355

Back center seam
style:back central
seam with V shape
opening

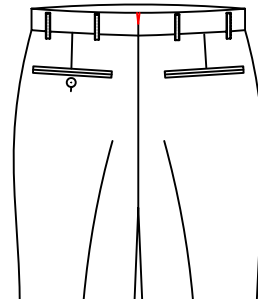

T-335C

Back center seam
style:Back central
seam V shape vent
opening

Back waist knoting style

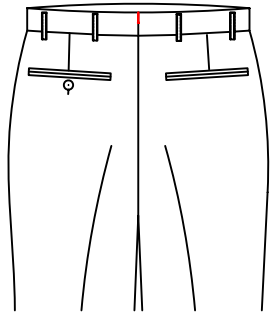

T-329D

Back waist knoting style:
Handmade back
seam-'I' shape opening

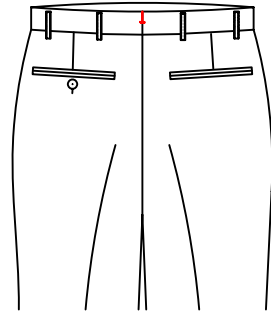

T-335G

Back waist knoting style:
Back waistband seam
with machine made bartack

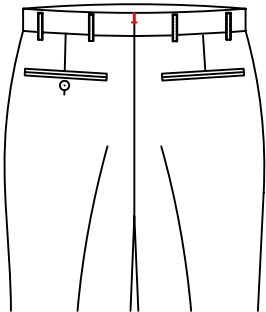

T-335F

Back waist knoting style:
Back waistband seam
with flat bartack

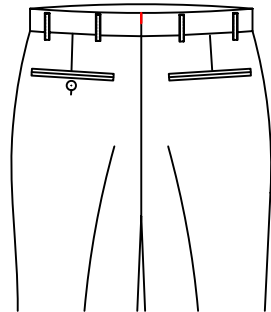

T-329K

Back waist knoting style:
Back waistband seam
without bartack

The mid of back waist with V style knot for the opening

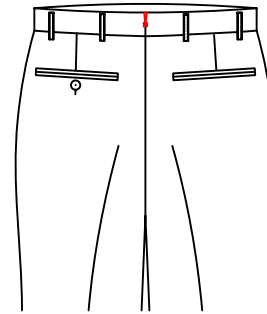

T-3359

The mid of back waist with V style,
knot for the opening:Red X
stitching on V Seam on pant

T-335S

back central seam V shape vent:
The thread of back central
seam V shape vent appointed

fly style

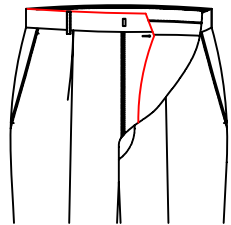

T-3400

fly style:
Fish-mouth fly

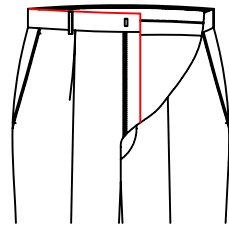

T-3401

fly style:straight fly

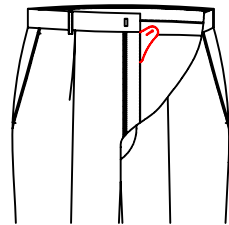

T-3402

fly style:Fish claw fly

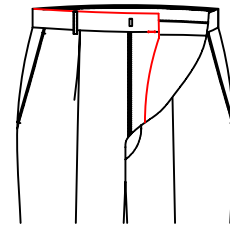

T-340G

fly style:Texas fly,1.7cm needle eyes on seam of fly

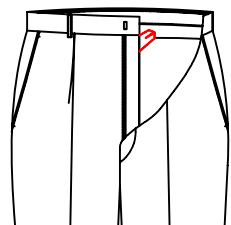

T-3403

fly style:French fly

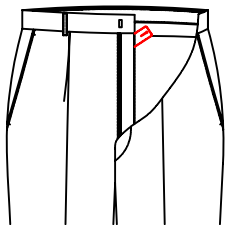

T-3404

fly style:small fish
claw shape squared
under fly

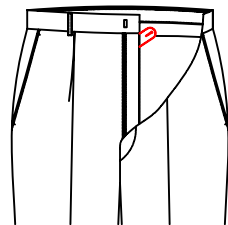

T-3405

fly style:small fish
claw shape rounded
under fly

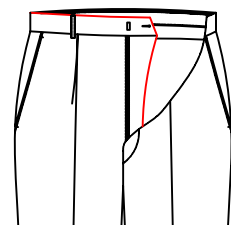

T-3406

fly style:Pointed fly

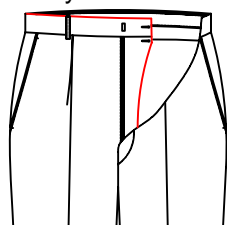

T-3408

fly style:Texas fly

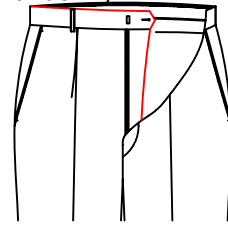

T-340E

Point trouser inner fly extension,
point extension in the middle of
waistband(buttonhole located
in the waistband)

The inner under closure fabric fabric of the back crotch

- △ T-340A Fly with pocketing fabric
- T-340B Inner fly with fabric
- T-340C Inner fly with pant lining
- T-340D Inner fly with customer appointed fabric

Extender

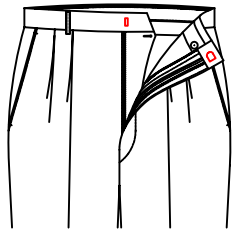

T-3410

No extension,with hook

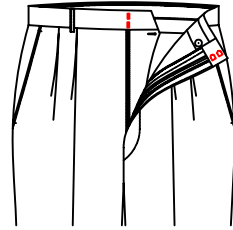

T-341J

No extension,with double hook

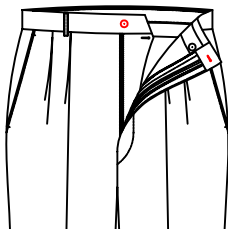

T-3411

No extension,with button

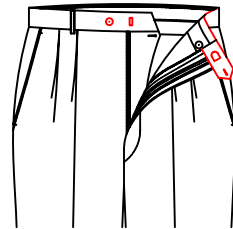

T-3412

△ Pointed extender with hook & button

Extender

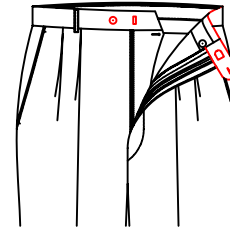

T-3413

Extension with button and hook

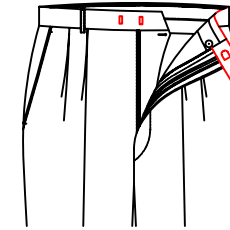

T-3414

Square extender with double hooks

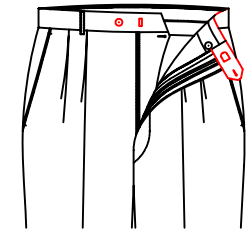

T-341H

Square extender with hook

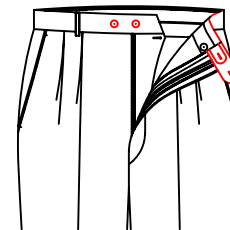

T-3415

Round extension with small extension

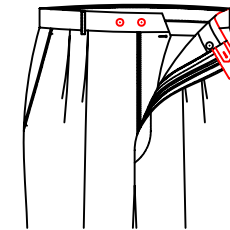

T-3416

Pointed extender attached small pointed extender

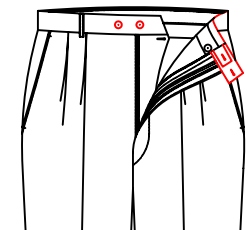

T-3417

Square extender with small square extender

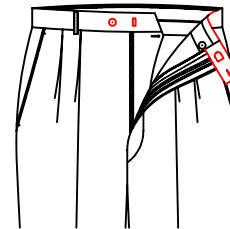

T-342A

Squared extender with hook and button

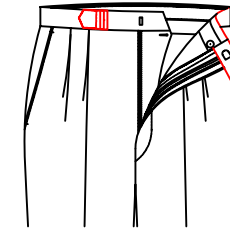

T-341M

Round extension with adjustable buckle

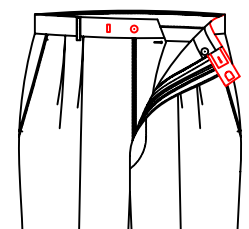

T-341F

Square extender with small extender and buttonhole and button

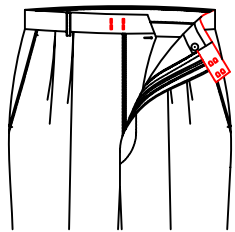

T-342Q

Square extender with four hooks

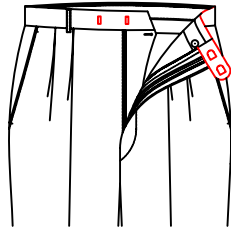

T-342R

Round extension with double hook

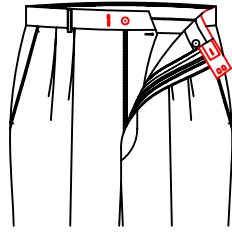

T-341s
Square extender with 2 hooks up and down, and small extender with button and buttonhole

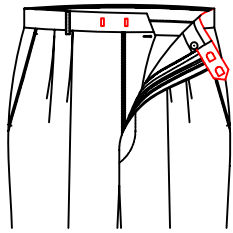

T-342T

Pointed extender with double hook

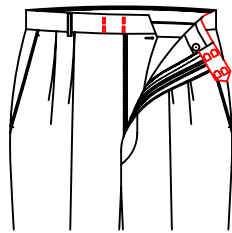

T-342U

Pointed extender with four hook (two in each UDLR)

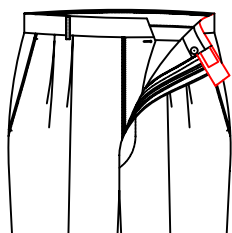

T-341V

Square extender with small square extender (no hook, buttonhole, button)

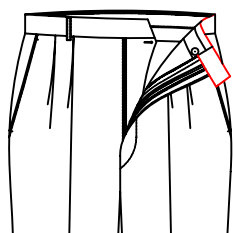

T-3429

Square extender (no hook, no buttonhole, no button)

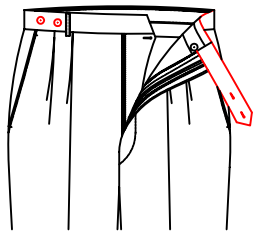

T-3428

Double buttonholes with buttons no hook

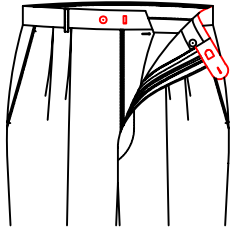

T-342C

Round extension with hook & button

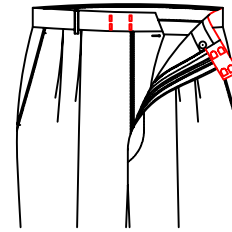

T-342D

Square extender with double buttonhole & button, double hook

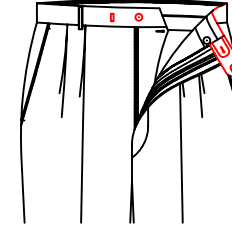

T-342H

Rounder extender, with button, and small extender with button and buttonhole

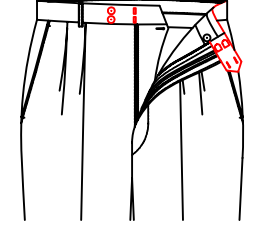

T-342L

Pointed extender with double buttonhole & button, double hook

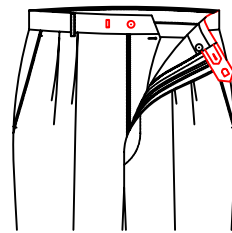

T-342P

Pointed extender with hook, and small extender with button and buttonhole

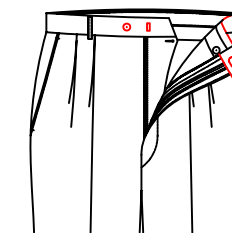

T-342V

Slant pointed extender with hook

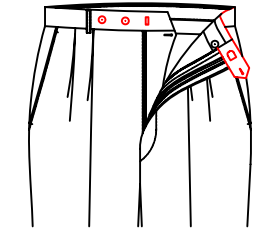

T-343K

Pointed extender with hook, 5cm distance to waistband with 1 decorative button

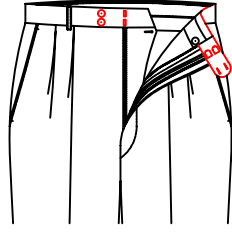

T-34AB

Rounded extender, with double buttonhole and double hook

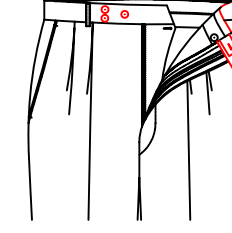

T-34AH

Square extender with a small extension

Hook

T-341K Customer request special hanger—

Extender length

- T-341A Extension length:7.5cm
- △ T-341B Extension length:5.5cm
- T-341C Extension length:6.0cm
- T-341D Extension length:6.5cm
- T-341R Extension length:20cm
- T-341T Extension length:4.5cm
- T-341U Extension length:5cm
- T-341X Extension length:15cm
- T-341Y Extension length:13cm

Waist extension pic stitch

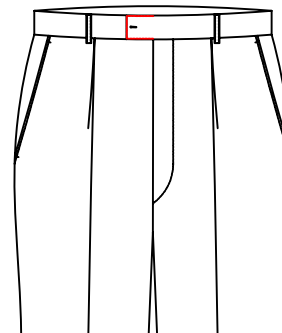

T-34L9

0.1cm top stitch on extender

Waist band Knot style

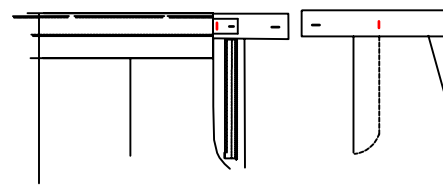

T-341N

Double extender with 'I' bartack

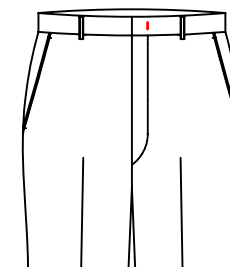

T-34LA

Vertical I bartack
(On the same line
of the front fly pic stitch)

Fly Style

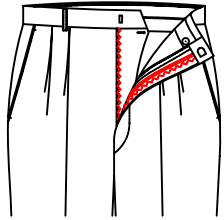

T-3420

△ Nylon zip

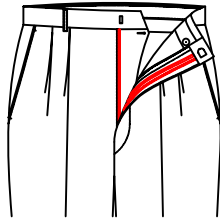

T-3421

Metal zipper

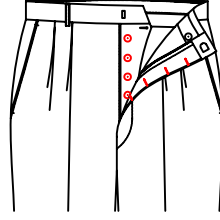

T-3422

Buttons on front fly

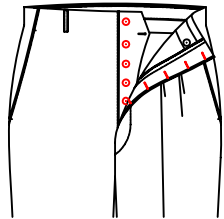

T-3425

Button fly



T-3424

Appointed front fly zipper

Belt buckle loop

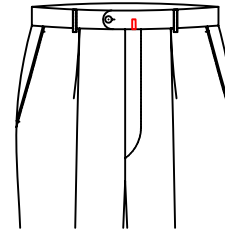

T-3423

Belt buckle loop

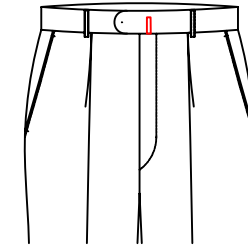

T-347B

Under the waist, add a net length of 3CM belt buckle

Fly button style

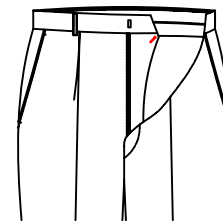

T-3407

Fly with slant buttonhole

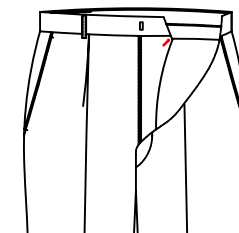

T-340R

Fly without buttonhole

Inner waistband

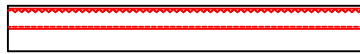

T-3430

Standard inner waistband



T-3431

Piped waistband with pick stitch



T-344E

Customer appointed piping



T-3432

Fabric label waistband



T-3434

△
Waistband W/Pleated Curtain



T-3435

Pleat waistband with Griplets



T-3436

Pleat waistband with snugtex



T-3440

Normal inner waistband with snugtex



T-3441

Standard waistband with pant lining piping and snugtex



T-3442

Light blue snugtex waistband



T-3443

Gripper waistband

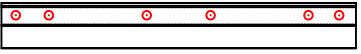

T-3444

Suspend buttons waistband



T-3449

Standard waist with suspender Buttons and snugtex



T-3445

Pleat waistband with snugtex,button



T-3437

White normal inner waistband



T-3438

White normal inner waistband with snugtex



T-3439

White pleat inner waistband



T-343B

Black pleat inner waistband



T-3448

Handmade waistband



T-344F

Customer request special waistband suspender button

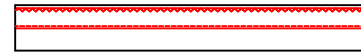

T-344H

Customer appointed inner waistband

T-343C Pleated waistband with customer appointed piping

T-343D Fabri waistband with Pant lining piping

T-343E Standard Inner waistband add pant lining piping, pick stitch,pick stitch customer appointed

T-343G Standard Inner waistband add appoint ribbon

T-343H Black standard Inner waistband

T-3495 Customer appointed waistband fabric, matching fabric binding

T-3496 Fabric waistband with binding,appoint the binding lining

T-3497 Standard waist with suspender

Inner waistband suspender button

T-344U Inner waistband suspender button

T-344M Customer appointed suspender buttons inner waistband--

Inner waistband with Griplets

T-344Y Inner waistband with Griplets

T-344Z Customer appointed inner waistband Griplets

T-3426 Inner waistband sideseam with Griplets(only two)

T-3427 Inner waistband sideseam with blue snugtex
(length 12cm and only two)

Straps Button

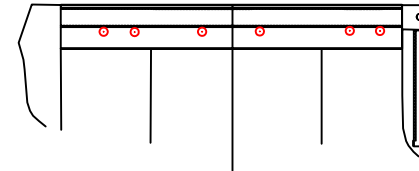

T-344Q

Straps button sewn in overlap of inner waistband and waist seam

T-344X Customer specified straps buttons attached on
where inner waistband and waistband seam meet

T-345Y Do not sew strap buttones to pant and put into
the back pocket delivered with the garment.

T-346A Customer appoint Straps button position of waistband
1cm to Waist mouth

T-34JA Specified Straps buttons attached on where outer
waistband and waistband seam meet

Inner waistband material

- T-3446 customer appointed materials for inner waistband,pocket,pocket wrapping,under closure, small rise,small rise piping and placket piping
- T-344W :customer appointed materials for inner waistband,pocket, under closure, small rise,small rise piping and placket piping
- T-344R :customer appointed materials for inner waistband under closure, small rise,small rise piping and placket piping
- T-344D Material matched body fabric with fish bone fabric for inner waistband , pocketing,pocketing piping,bottom fly fabric,crotch fabric,crotch piping,front fly
- T-344S :fabric matched body fabric with fish bone fabric for inner waistband pocketing piping,bottom fly fabric,crotch fabric,crotch piping,front fly
- T-344J :fabric matched body fabric with twilled cotton fabric for inner waistband ,pocketing,pocketing piping,bottom fly fabric, crotch fabric,crotch piping,front fly
- T-344G fabric matched body fabric with twilled cotton fabric for inner waistband , pocketing piping,bottom fly fabric,crotch fabric,crotch piping,front fly
- T-344T fabric matched body fabric with twilled cotton fabric for inner waistband , bottom fly fabric,crotch fabric,crotch piping,front fly
- T-344P fabric matched twilled cotton fabric for inner waistband , pocketing,pocketing piping,bottom fly fabric,crotch fabric, crotch piping,front fly
- T-344K Fabric matched body fabric with twilled cotton fabric for inner waistband, pocketing,pocketing piping,crotch fabric,crotch piping,front fly
- T-344L fabric matched body fabric with twilled cotton fabric for inner waistband,crotch fabric,crotch piping,front fly
- T-344N fabric matched body fabric with twilled cotton fabric for innerwaistband, crotch fabric,crotch piping,front fly
- T-342Y Customer appointed materials for small rise,small rise piping,front fly piping-
- T-342F customer appointed materials for pocket,small rise, small rise piping and placket piping
- T-342E customer appoint fabric for pocket, pocket wrapping, under closure, small rise,small rise piping and placket piping
- T-342B customer appoint fabric for pocketing,pocketing piping, back of fly,crotch,crotch piping,back crotch,back crotch piping

Inner waistband with customer appointed

- T-344C Customer appoint fabric for inner waistband(only use pocket fabric-)

Hardness of waistband

- T-344A Hardness of waistband inside:Double fuse waistband
- △T-344B Hardness of waistband inside:soft inner waistband

Inner waistband

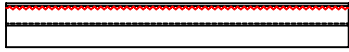

T-34W9

Hand made



T-34W8

Top stitch inner waistband

Inner waistband sewing form

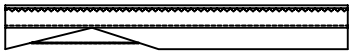

T-345M

Hand made

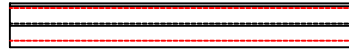

T-34W0

Top stitch inside waistband

Inner waistband Top stitch

T-34J0 customer appointed inner waistband top stitch-

Button sewing form

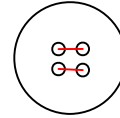

T-345A

△ "=" shape

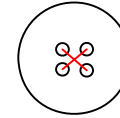

T-345B

"+" shape

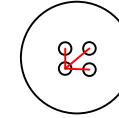

T-345C

Claw shape

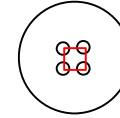

T-34Y1

square button
sewing form

Buttonhole and Buttoning Style

Default T-345D Machine-made buttonholes
T-345E Hand-made buttonhole and buttoning

Buttonhole and Buttoning Request

T-35G8 Extension and back pocket with buttonholes but no buttons
T-35G9 Lack of customer-supplied buttons then
no customer-supplied buttons for pants

Extender with Fabric-cover Button

T-341L Extender with fabric-covered button-
T-343L Extender with customer appointed button-
(Please ignore this option if no button for extender)

Buttonhole Thread

Default T-345F Buttonhole thread matched fabric color
T-345G Customer appointed buttonhole thread-

Buttoning Thread

Default T-345H Buttoning thread same as buttonhole thread
T-345J Customer appointed buttoning thread-
T-345K Buttoning thread matched the color of buttons-

001 Button



T-3450
Nut button



T-3451
Horn button



T-3453
Fabric-covered buttons
only for back pockets



T-3456
Fabric-covered
button with customer
appointed fabric-



T-3454
Customer appointed
button



T-3455
Satin-covered button
only for back pockets-

T3458 Fabric-covered button (all buttons)
T3459 Satin-covered button (all buttons)
T345Q Fabric-covered flat buttons (all buttons)
T345R Fabric-covered flat button with customer appointed fabric-
T345Z Customer appointed buttons for back pockets-

Pant Lining

Default T-350A White pant lining
T-350B Black pant lining for dark fabric, white lining for light color fabric
T-350D Customer appointed pant lining-
T-350F Customer request special pant lining- FLL60-X-74

Pic stitch thread

T-3628 Customer appointed thread pic stitch

Standby button on inner waistband

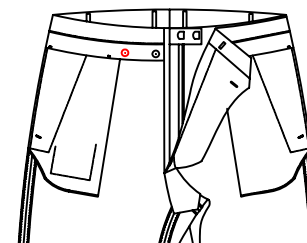

T-345N

A standby button on inner waistband
(8cm distance from the back fly inner button)

Lining Style

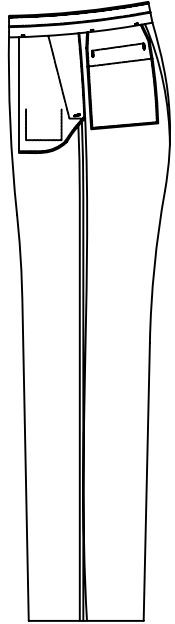

T-3500
No pant lining

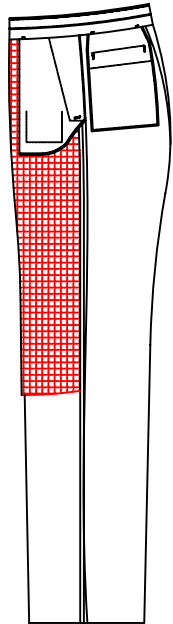

T-3501
Default Front lining,
pocket outside the lining

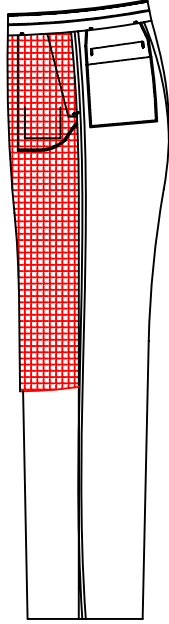

T-3502
Front lining,
pocket inside the lining

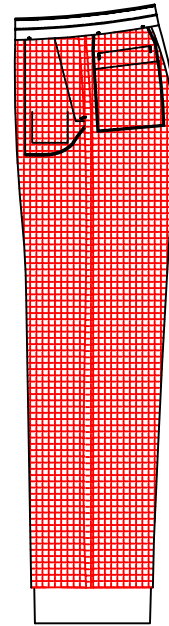

T-3507
Cylinder full trouser lining

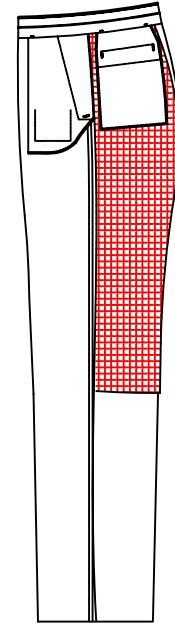

T-3508
1/2 back lining, pockets outside

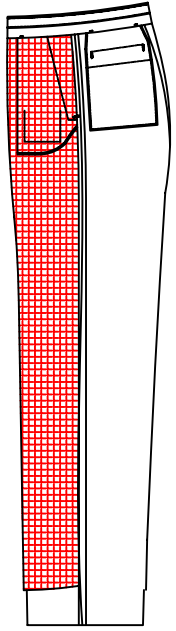

T-3509

Front whole lining,
pocket inside

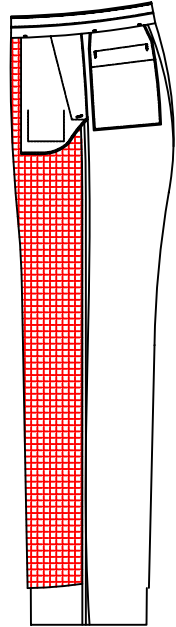

T-350E

Front whole lining,
pocket outside

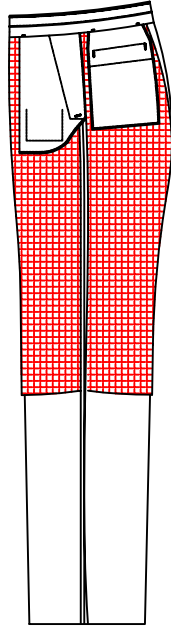

T-3503

Front and back
half lining with
pocketing outside

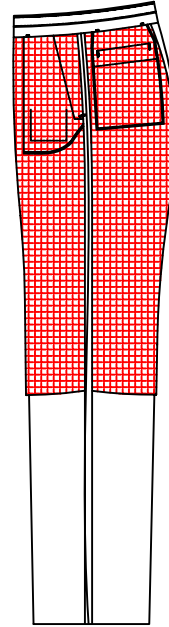

T-3504

Half lining,
pocket inside

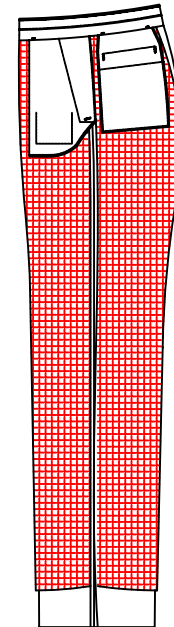

T-3505

Full pant lining
with pocketing outside

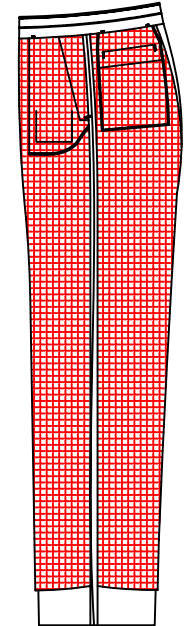

T-3506

Full pant lining
with pocket inside

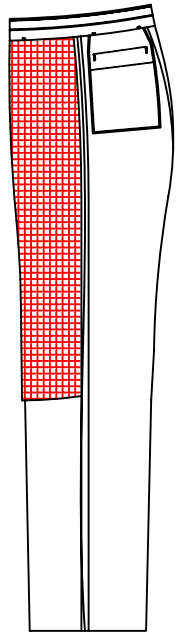

T-350G

Front with half lining

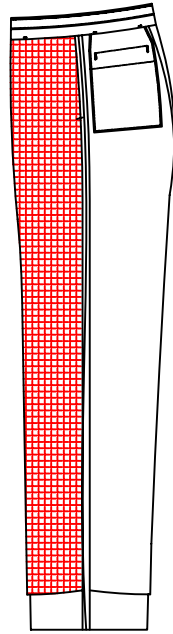

T-350H

Front with whole lining

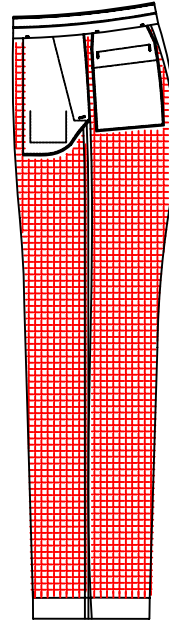

T-350Q

Full lining ,
pocket outside ,
lining down to
bottom edgefold

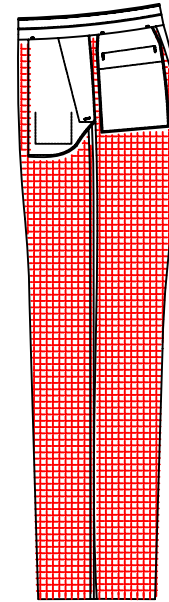

T-350R

Full lining front and back
(lining extends to unfinished hem),
pocket outside of lining
(ignore this if there's no pocket)

Type of pocket and U-rise bottom

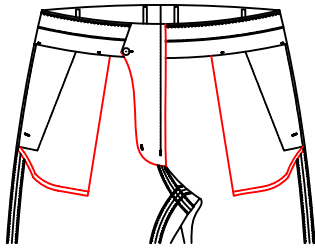

T-35M1

Square pocket inner
pick stitching no crutch

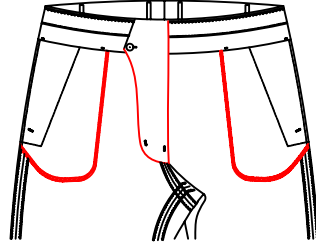

T-35M2

Rounded pocketing
binding, (no crutch), net fly

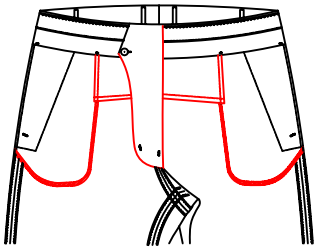

T-35M3

Rounded pocketing binding,
with single layer fly

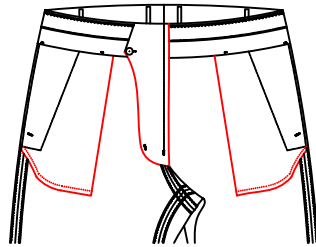

T-35M4

Square pocket inner 0.5cm
pick stitching no crutch fabric

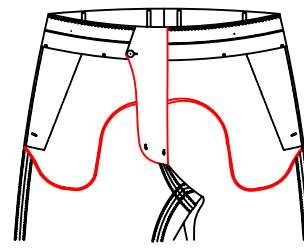

T-35M5

Conjoined pocket inside
with stitching, under fly
without crutch fabric

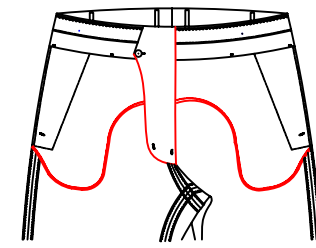

T-35M6

Conjoined pocket inside
with 0.5cm pic stitch,
under fly without crutch fabric

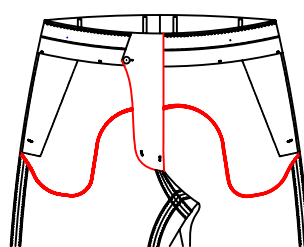

T-35M7

Conjoined pocket with
piping, under fly without
crutch fabric

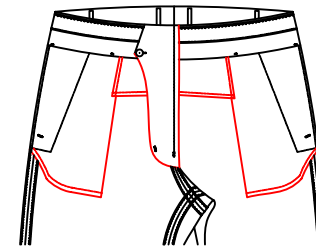

T-35M8

Square pocket inner sewing
outer top stitch with single
layer top fly fabric, no crutch

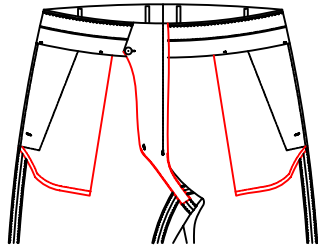

T-35A1

Square pocket inner with top stitch,
bottom placket with tail

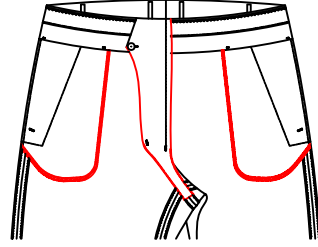

T-35A2

Round pocket with piping,
under closure with tail

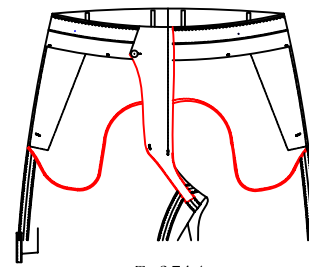

T-35A4

Pocketing with top stitch outside,
bottom fly fabric with tail

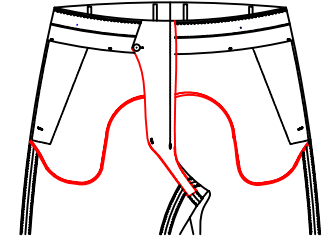

T-35A5

Connection pocketing with
pick stitch, crotch cover
with tail

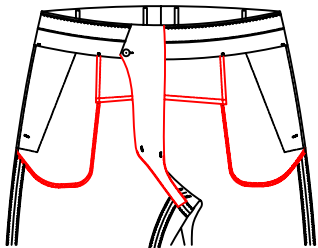

T-35B7

Round pocketing with piping,
single layer cloth attached to
front fly, bottom fly with tail

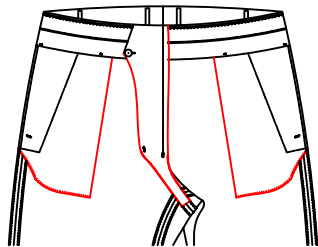

T-35A3

Stitch from inner square
pocket to outer square pocket

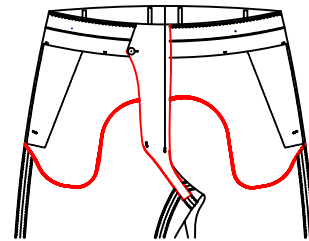

T-35C6

Conjoined pocket with piping,
under fly with extra fabric

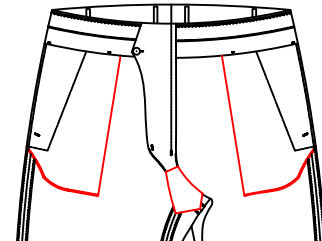

T-35A6

Square pocket inner pick
stitching diamond crutch

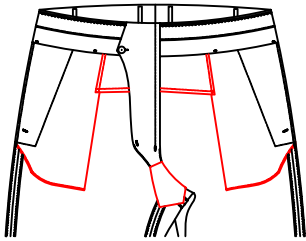

T-35C7
square pocket inner sewing outer top stitch with single layer top fly fabric, diamond crutch

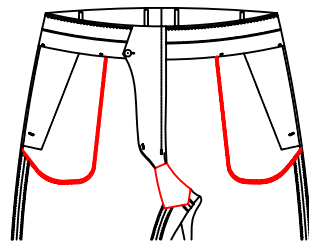

T-35A7
round inner pocket with piping

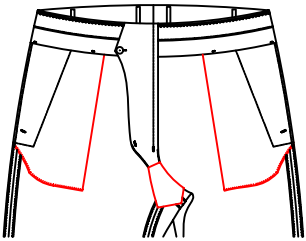

T-35A8
Conjoined pocket inside with stitching ,diamond crutch fabric

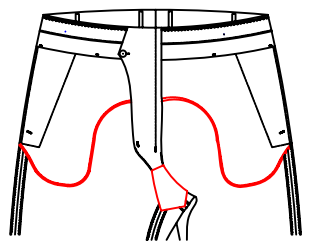

T-35A9
Conjoined pocket inside with stitching ,diamond crutch fabric

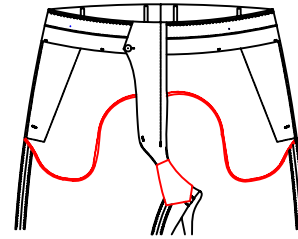

T-35B1
Conjoined pocket inside with 0.5cm outside pic stitch,diamond crutch fabric

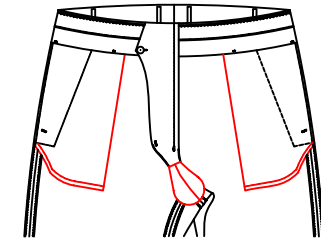

T-35B2
square pocketing with top stitch outside,oval crutch fabric

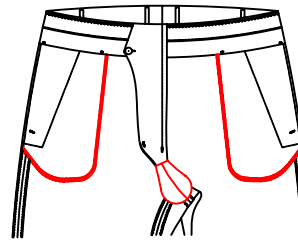

T-35B3
△ Round Pocketing with binding, crutch with ellipse shape gusset

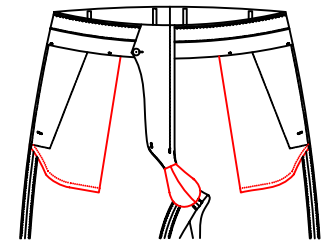

T-35B4
Square pocketing with top stitch,crutch with ellipse gusset

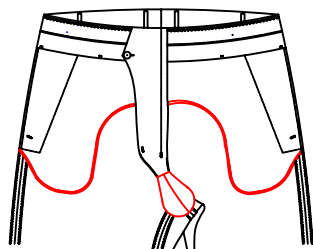

T-35B5

Conjoined pocket inside with stitching, ellipse crutch fabric

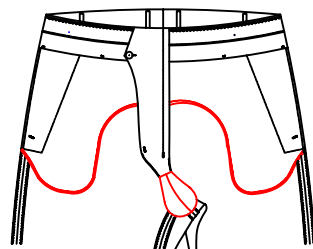

T-35B6

Conjoined pocket inside with 0.5cm pic stitch, ellipse crutch fabric

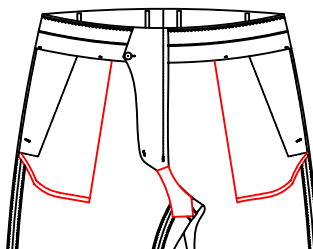

T-35A0

square pocket inner pick stitching QX crutch fabric

Pocket fabric

T-35C1 Pocket fabric-customer appointed

T-35C2 Pocket fabric in match suit fabric, cotton stripe trim fabric

Pocket piping

T-35B9 pocket piping customer appointed fabric

T-35B0 pocket piping using reverse side with customer appointed fabric

T-35C5 Extra fabric on front pocket to avoid pocket pop(plain pant only)

Bottom fabric of the back crotch

△T-3514 bottom fabric of the back crotch:no crotch

T-3515 bottom fabric of the back crotch:Crotch with fabric

T-3516 bottom fabric of the back crotch:Crotch with pant lining

T-3517 Crotch curtain use customer appointed fabric--

T-3518 use innerlining,color matching fabric, large crotch curtain

Extra fabric on front pocket to avoid pocket pop (plain pant only)

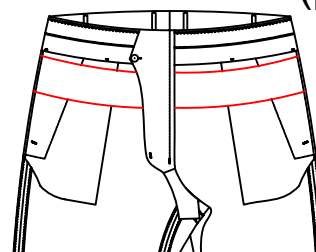

T-35C3 Extra fabric on front pocket to avoid pocket pop(plain pant only) T-35C8 Extra fabric on front pocket--use fabric

Back rise

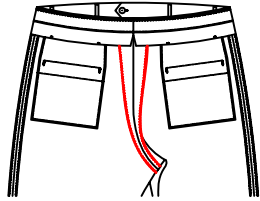

T-3520
△ Back rise stitched

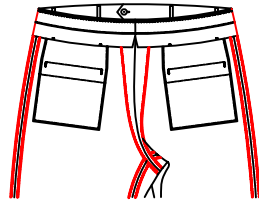

T-3523
net shape wrapping all used on side seam, inner seam and back crotch seam

T-3522 front fly and back rise sewn piping, piping use fabric--

T-352B Piping match pant lining on back rise

T-352E back rise piping use fabric--

Coin pocket

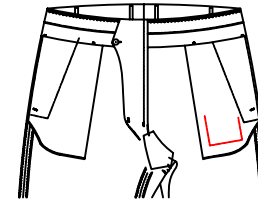

T-3530
△ Right coin pocket

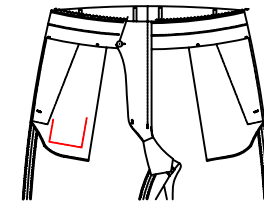

T-3531
Left coin pocket

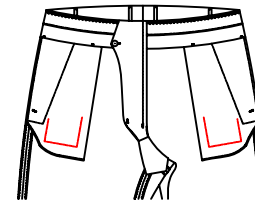

T-3532
Left & right coin pocket

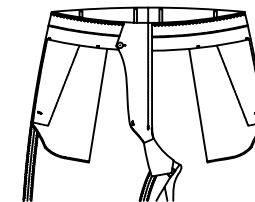

T-3533
No coin pocket

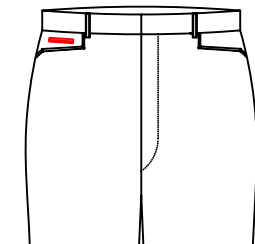

T-3534
double besom right change pocket (only for jeans pocket)

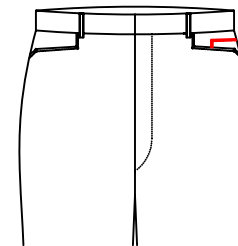

T-3535
left patch change pocket (just for jeans pocket)

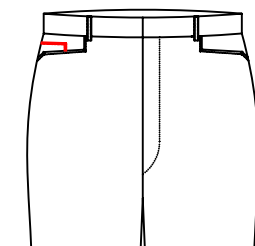

T-3536
patch change pocket (just for jeans pocket)

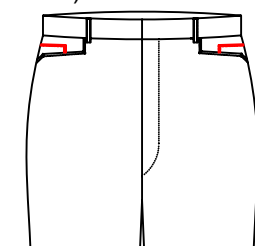

T-3537
left and right patch change pocket(just for jeans pocket)

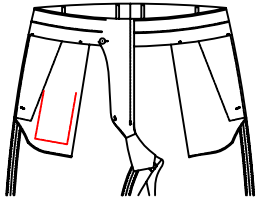

T-353J

Left cell phone pocket
(not reveal the bag,
only for the slant
pocket)width 9.5*
height 11cm

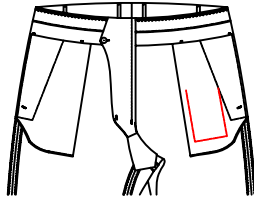

T-3538

Right cell phone pocket
(not reveal the bag, only
for the slant pocket)
width 9.5* height 11cm

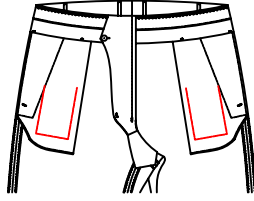

T-353E

Left & right cell phone
pocket(not reveal the bag,
only for the slant pocket)
width 9.5* height 11cm

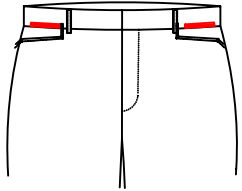

T-353D

Left & right double besom
coin pocket(only for denim
pocket)

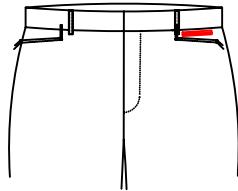

T-353C

Left double besom
cion pocket(only
for denim pocket)

Bottom style

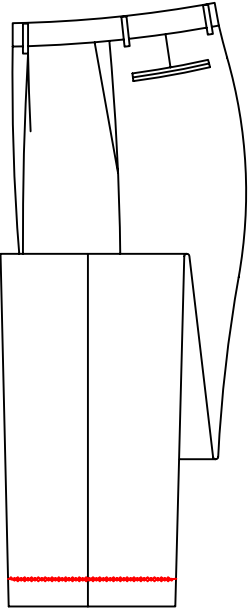

T-3600

△ Plain 5.0cm

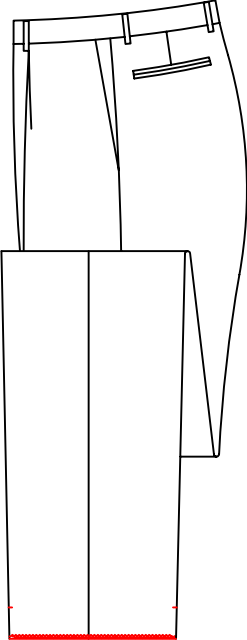

T- 360J

Unfinished with 5cm extra fabric

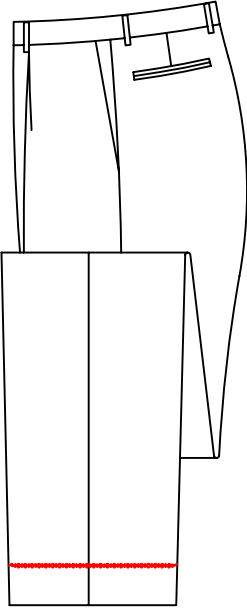

T-3607

Plain 6.4cm

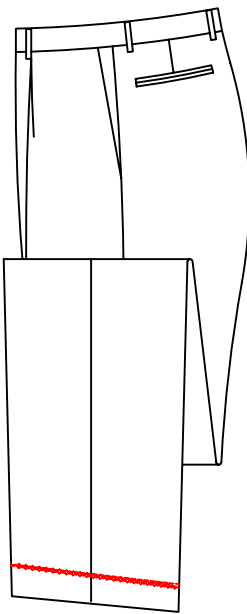

T-360K

slant bottom with 4cm inner edgefold

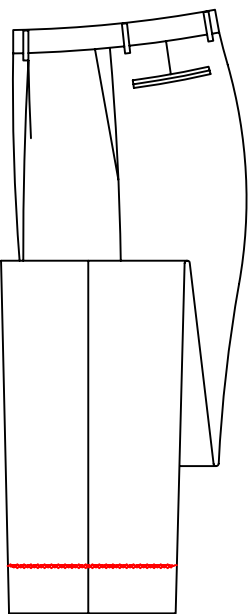

T-3608

Plain bottom 7.0cm

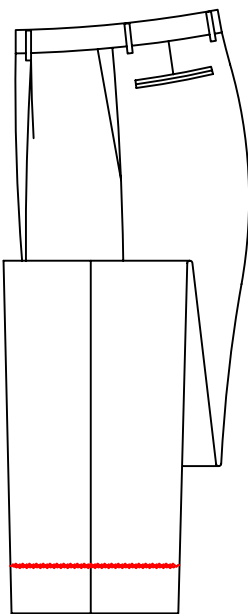

T-3609

Plain 7.6cm

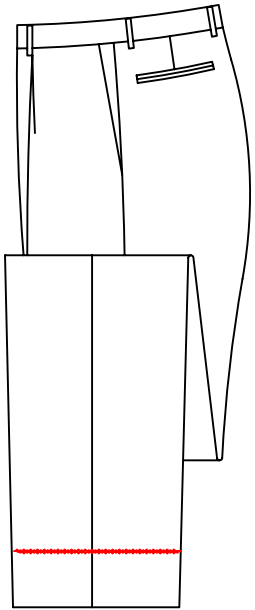

T-360H

Plain 9cm

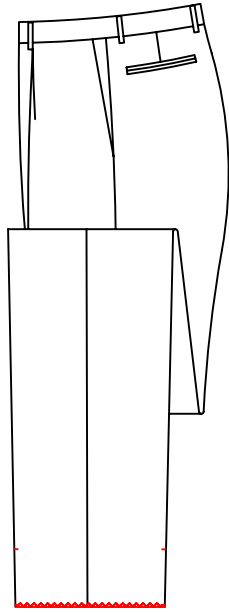

T-360G

Unfinished pant bottom with
10cm extra fabric

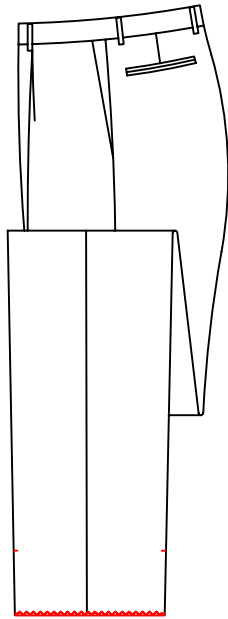

T-3601

Unfinished pant bottom with
11.5cm extra fabric

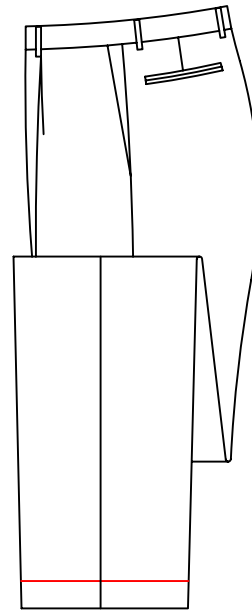

T-3602

3.2cm cuff

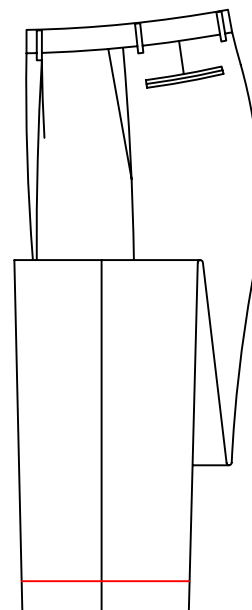

T-3603

3.8cm cuff

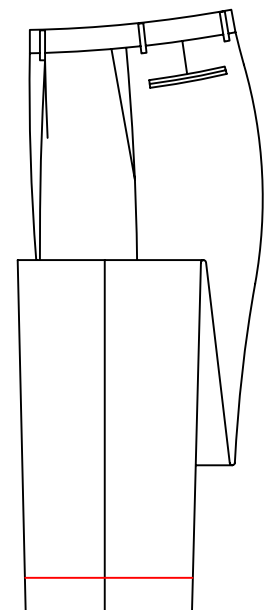

T-3604

4.4cm cuff

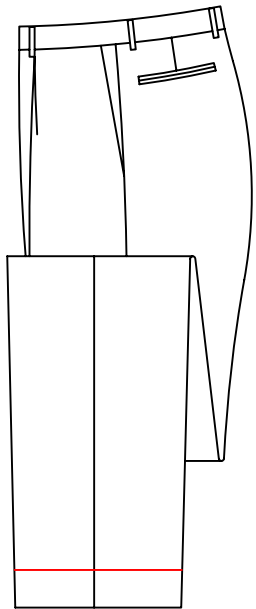

T-3605

5.1cm cuff

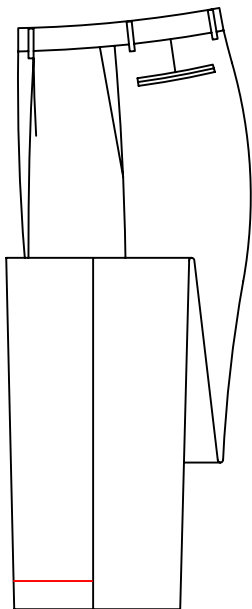

T-3606

3.8cm front cuff

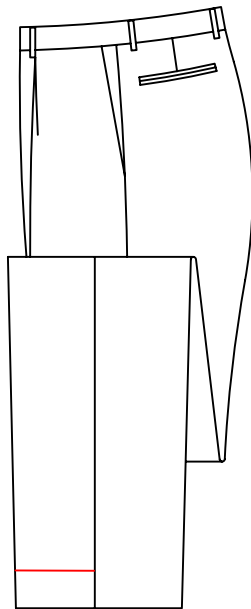

T-3627

5.1cm front cuff

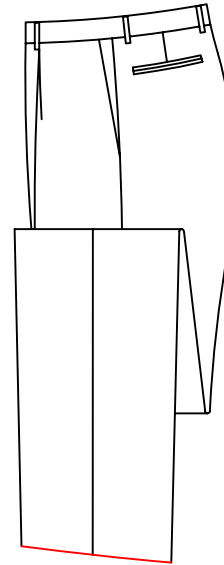

T-3624

Boot cuff(plain 4.0cm only)

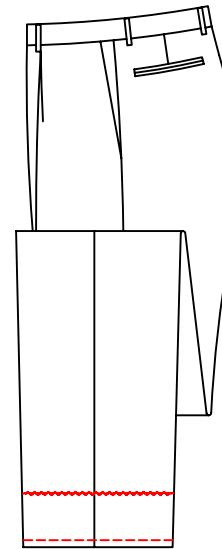

T-360B

7.6cm plain bottom,
add top stitch on 1.3cm to
the bottom

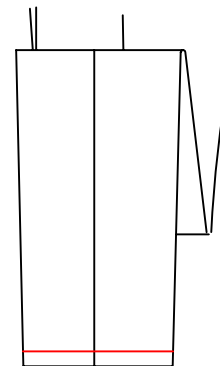

T-360L

2.5cm cuff

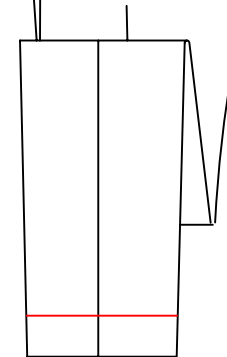

T-360M

6cm cuff

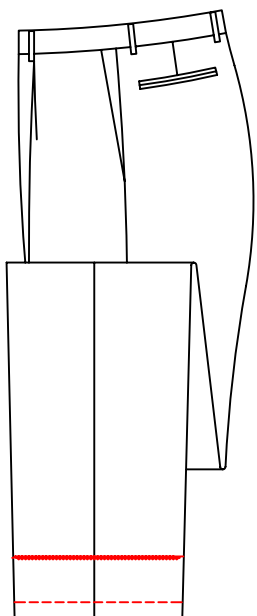

T-360C

7.6cm plain bottom,
2.5cm top stitch

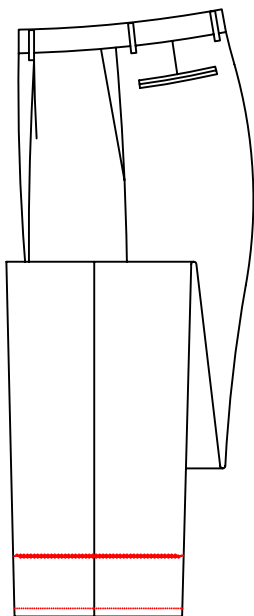

T-360D

7.6cm plain bottom,
1.3cm pic stitch

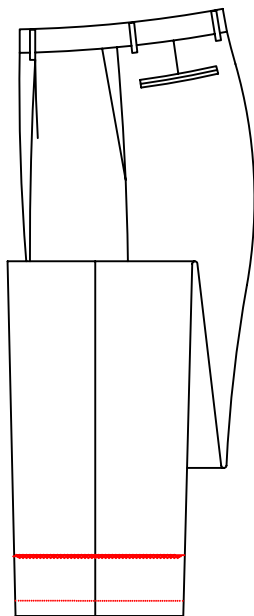

T-360E

7.6cm plain bottom,
2.5cm pic stitch

unfinished bottom style

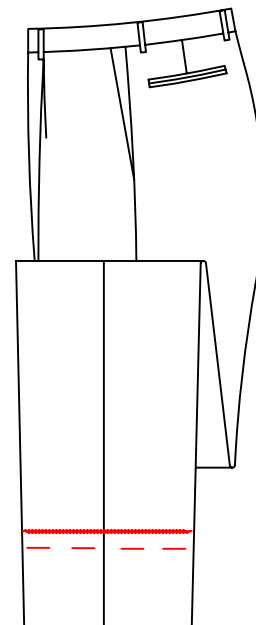

T-3625

unfinished bottom,
fold up and fix by baste stitching

Sewing style of pant bottom

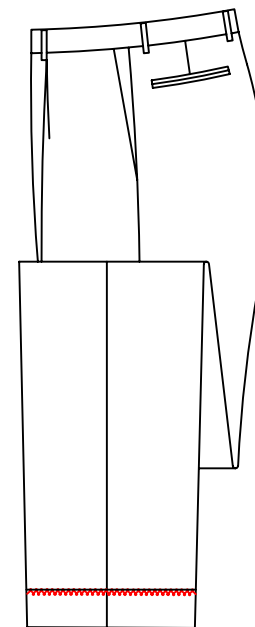

T-3629

sew trouser bottom manually
(unfinished bottom and cuff and
other not suitable craft is ignore it)

side seam of the pant bottom

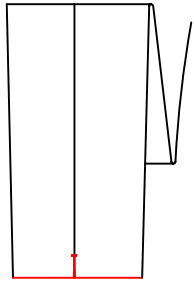

T-3620

pant bottom vents 2.5cm

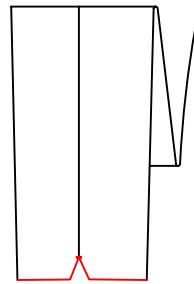

T-3621

2.5*2.0cm
triangle opening on
both sides of pant bottom

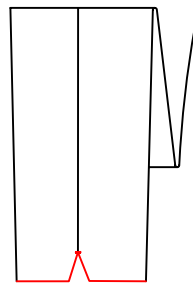

T-362A

triangel opening
on side pant bottom,
size 3.2cmX2.5cm

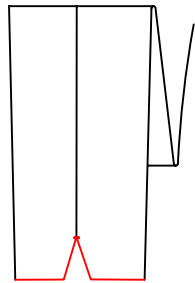

T-362B

side seam of
the pant bottom:
triangel opening
on side pant bottom,
size 5.1cmX3.8cm

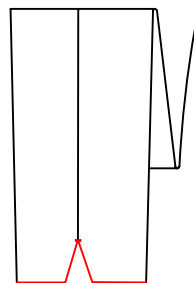

T-362C

Inner and outside vents
length of leg opening
is 5.1cmX3.8cm

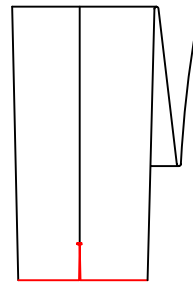

T-3626

the vents for the
outside leg opening is 3.2cm

brand label position

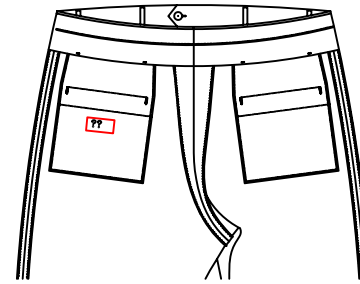

T-3640

brand label below 1.0cm
of the right pocket bottom-

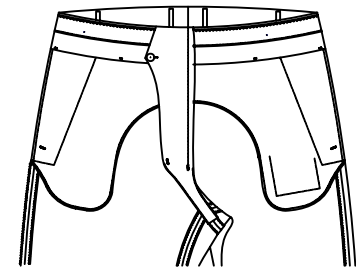

T-3641

△ No Brand label

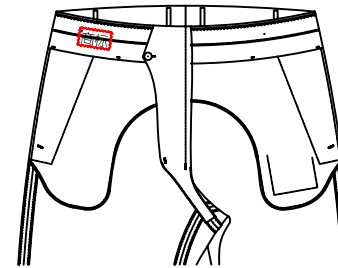

T-3642

brand label in the center
of left front waistband-

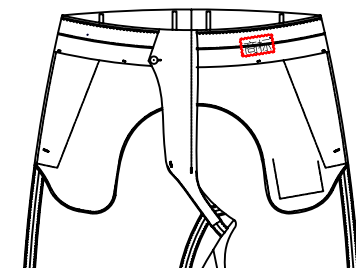

T-3643

brand label in the center
of right front waistband

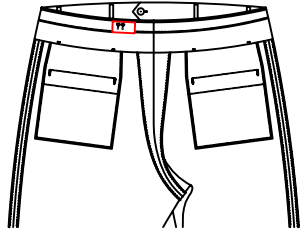

T-364F

Brand label in the right of the back center seam of waist band-

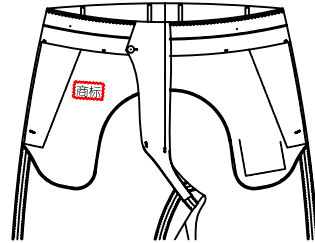

T-364B

brand label in the center of left front pocket-



T-3645

Brand label sewing on the snugtex in the center of right front waistband 8cm from the first beltloop to side seam



T-3644

Brand label sewing under the snugtex in the center of right front waistband 8cm from the first beltloop to side seam

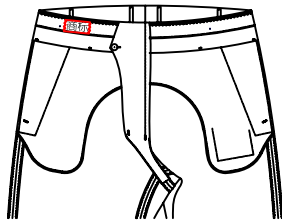

T-364Z

Brand label in the left front of the waist band 12cm from upside and placket/ both side side seams

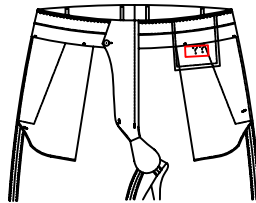

T-364E

Brand label add on 3cm above right waist card pocket fabric

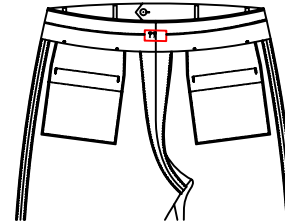

T-364A

Brand label in the center of back waistband-



T-364C

Brand label in the center
of right front pocket

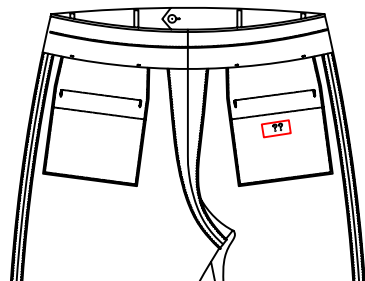

T-364D

Brand label in the left
back pocket bottom 1cm below

Fabric loop position

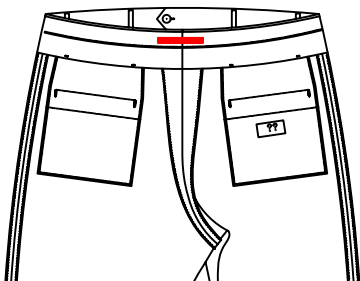

T-364Y

Pocket fabric loop in center of back waistband

Fabric lable position

- △ T-3647 No fabric label
- T-3648 Right front inner waist band make with brand label
- T-3649 Left front inner waist band make with brand label
- T-364G Back inner waist band make with brand label
- T-364H Left front fabric pocket centre make with brand label
- T-364J Right front fabric pocket centre make with brand label
- T-364K Brand label make on the left bottom fabric

Name label position

- △ T-3651 No name label
- T-3652 Name label on central right front inner waistband
- T-3653 Name label on central left front inner waistband
- T-365A Customer name label sewned on the middle of backwaistband
- T-365B Name label in the middle of front left pocket
- T-365C Name label stitching in the middle of right front pocket
- T-365D Name label 1cm under left back pocket

Care Label position

- T-3633 No care label
- △ T-3634 Care label in left hip pocket
- T-3635 Care label stitched in the back right pocket
- T-3636 Care label guest specified in the back pocket
- T-3637 Right back pocket customer appoint care label-

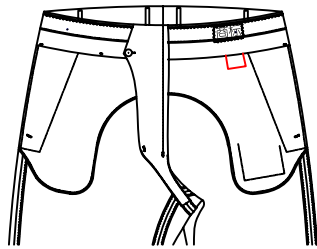

T-3638

Care label in the right front inner waistband

Origin label position

- △ T-3661 Attach Made in China on care label
- T-3662 No origin label

Sewing label thread

T-3665 customer appointed label sewing thread

Label sewing form

T-3667 hand attached labels

T-38C2 plain stitch brand label

Hanging label position

T-3671 customer appointed tag

Price on hanging label

T-3681 hang tag with selling unit price--

Show specification on hang tag

T-38E1 Hang tag with finished garment size

Print fabric number

T-36A1 printing customer appointed fabric# on care label

T-38H1 print the fabric number on tag

T-38H8 tag and washing label print appointed fabric code

T-36A0 fabric No. not showing on the care label

Print fabric composition

T-36A4 print customer appointed fabric composition on care label

T-38H3 print the appointed fabric composition tag

T-38H2 hang tag and washing label printing
appointed fabrics compositions

Print lining composition

T-3675 the lining composition showing on the care label

T-38H4 Print the lining composition on tag

T-38H9 hang tag and washing label marking lining compositions

Mark trim composition

T-3685 trim composition showing on the care label

T-38H7 mark trim composition on tag

T-38H6 mark the trim composition on tag and care label

Thigh adjustment

T-3701 Reduce 2cm on thigh

T-3702 Reduce 3cm on thigh

T-3703 Reduce 4cm on thigh

T-3709 Reduce 1cm on thigh

Size label position

T-3664 Stitched the appointed size on care label

Belt loop quantity

- T-3716 customer request 6 sets belt loops
- T-3717 customer request 7 sets belt loops
- T-3718 customer request 8 sets belt loops
- T-3719 customer request 9 sets belt loops
- T-3714 customer request 5 sets belt loops
- T-3726 customer request 15 sets belt loops
- T-371D customer request 11 sets belt loops

Return extra fabric

- T-3715 return extra fabric

Ironing requirement

- T-3720 Press with no crease on front center pant

Only shipping belt loops

- T-3711 8 beltloops more needed
- T-371B make extra 8 belt loops with 1.3cm width
- T-371A make extra 8 belt loops with 2cm width
- T-3712 make extra 8 belt loops with 3.2cm width
- T-3713 make extra 8 belt loops with 3.8cm width
- T-3710 make extra 8 belt loops with 5.0cm width
- T-371C make extra 2 belt loops with 2cm width

Back fake pocket style

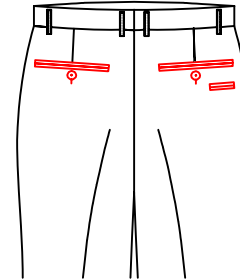

T-3266

double besom decorating pocket
2.5cm below right back pocket
(pocket opening 5cm)

Attach fabric sample

T-3953 Fabric sample(5cm square) sent with garment

Accessories ship

T-3954 Extra buttons and threads put into specify envelope

Customer appointed sticker

T-3952 Attach customer appointed sticker onto the hangtag and top-right corner of the outer plastic bag

Cutting style

T-3729 horizontal cutting

T-3730 cut fabric flowing along the velvet

△ T-3731 cut fabric inverse the velvet

Order bar code label position

T-3892 Bar code label stitched on the extender

Casual side pocket style

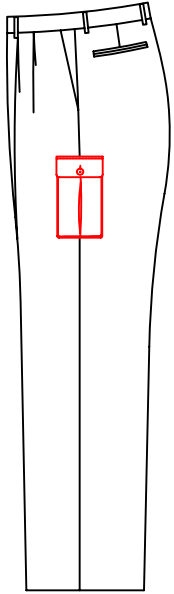

T-329C

side patch pocket with flap,
flap with one pleat
and button&buttonhole
17cm below the pant side pkt

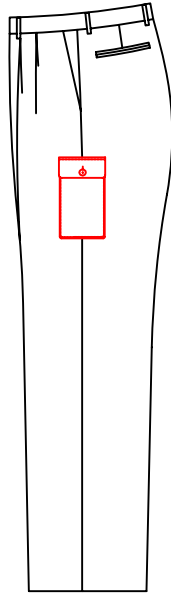

T-329H

side patch pocket with flap,
flap with button and buttonhole
17cm below the pant side pkt

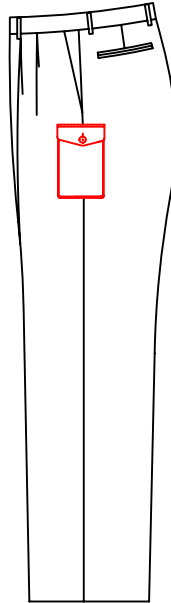

T-328D

Side seam pockets
under 4cm plus
affixed side
pockets with
diamond-shaped
flaps and with
buttonhole

fly seal requirement

T-3900 fly with hidden stitching

bartack style on back pocket

T-3901 Bartack on Hip pocket through pocket lining

Name Tag Source

T-365L Name label with customer appointed

Customer order number on washing label

T-39P9 Original customer order number on washing label

hand sewn outter pic stich

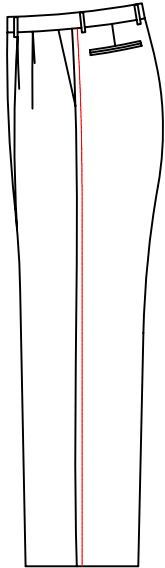

T-332K hand sewn outter pic stich